

USER MANUAL

G-MASTER

LCD Monitor

ENGLISH

G-MASTER GB3467WQSU

Thank you very much for choosing the iiyama LCD monitor.

We recommend that you take a few minutes to read carefully through this brief but comprehensive manual before installing and switching on the monitor. Please keep this manual in a safe place for your future reference.



Dear user, we congratulate you on the purchase of your iiyama LCD.

For details on warranty and locally used pixel policies that apply directly after installation of your product please check the iiyama website.

To report a fault, please contact your local support centre found at www.iiyama.com/service

Things to check before you call the iiyama information line

- | if the power cable is connected securely and turned on?
- | if the display has been turned on?
- | if the signal cable is connected securely and the correct input selected?
- | if the computer has been restarted with the display connected?
- | if the graphics card is correctly installed with the latest drivers possible?
- | if the correct native resolution has been selected via 'Display Properties'?
- | If the R/G/B signal configuration is correct?
- | if the displays On Screen Menu is shown?
- | if the correct brightness and contrast settings have been set?
- | if given display tolerances and compatibility have been considered?
- | if via the On Screen Menu you have performed a Factory Reset/Recall?

Before reporting the screen defect, please prepare the following information/evidence:

- | model number *
- | purchase receipt and serial number *
- | name and address for collection
- | telephone/fax number, for availability during the day
- | convenient collection date (date, time)
- | short description of the defect

Important Note:

If there is no fault found in the collected equipment after inspection, the transferring party shall incur charges for transport and administration.

If you have checked all of the above and there is still no picture, call our information line for assistance in your country.

* see the identification plate on the back of the case.

CE MARKING DECLARATION OF CONFORMITY

This LCD monitor complies with the requirements of the EC/EU Directive 2014/30/EU "EMC Directive", 2014/35/EU "Low Voltage Directive", 2009/125/EC "ErP Directive" and 2011/65/EU "RoHS Directive".

The electro-magnetic susceptibility has been chosen at a level that gives correct operation in residential areas, business and light industrial premises and small-scale enterprises, inside as well as outside of the buildings. All places of operation are characterized by their connection to the public low voltage power supply system.

IYAMA CORPORATION: Wijkmeerstraat 8, 2131 HA Hoofddorp, The Netherlands

Model No. : PL3467WQ



We recommend recycling of used product. Please contact your dealer or iiyama service center. Recycle information is obtained via the Internet, using the address: <http://www.iiyama.com>

You can access the Web page of different countries from there.

- We reserve the right to change specifications without notice.
- All trademarks used in this user manual are the property of their respective owners.
- Eprel registration number GB3467WQSU-B1 : 941714

TABLE OF CONTENTS

FOR YOUR SAFETY.....	1
SAFETY PRECAUTIONS.....	1
SPECIAL NOTES ON LCD MONITORS.....	3
CUSTOMER SERVICE.....	3
CLEANING.....	3
BEFORE YOU OPERATE THE MONITOR.....	4
FEATURES.....	4
CHECKING THE CONTENTS OF THE PACKAGE.....	4
INSTALLATION.....	5
FITTING AND REMOVAL OF BASE.....	6
CONTROLS AND CONNECTORS.....	7
CONNECTING YOUR MONITOR.....	8
COMPUTER SETTING.....	9
ADJUSTING THE HEIGHT AND THE VIEWING ANGLE.....	9
OPERATING THE MONITOR.....	10
ADJUSTMENT MENU CONTENTS.....	11
STANDBY FEATURE.....	24
TROUBLE SHOOTING.....	25
RECYCLING INFORMATION.....	26
APPENDIX.....	27
SPECIFICATIONS.....	27
DIMENSIONS.....	28
COMPLIANT TIMING.....	28

FOR YOUR SAFETY

SAFETY PRECAUTIONS

WARNING

STOP OPERATING THE MONITOR IF YOU ARE AWARE OF ANY PROBLEMS

If you notice any abnormal phenomena such as smoke, strange sounds or fumes, unplug the monitor and contact your dealer or iiyama service center immediately. Further use may be dangerous and can cause fire or electric shock.

NEVER REMOVE THE CABINET

High voltage circuits are inside the monitor. Removing the cabinet may expose you to the danger of fire or electric shock.

DO NOT PUT ANY OBJECT INTO THE MONITOR

Do not put any solid objects or liquids such as water into the monitor. In case of an accident, unplug your monitor immediately and contact your dealer or iiyama service center. Using the monitor with any object inside may cause fire, electric shock or damage.

INSTALL THE MONITOR ON A FLAT, STABLE SURFACE

The monitor may cause an injury if it falls or is dropped.

DO NOT USE THE MONITOR NEAR WATER

Do not use where water may be splashed or spilt onto the monitor as it may cause fire or electric shock.

OPERATE UNDER THE SPECIFIED POWER SUPPLY

Be sure to operate the monitor only with the specified power supply. Use of an incorrect voltage will cause malfunction and may cause fire or electric shock.

PROTECT THE CABLES

Do not pull or bend the power cable and signal cable. Do not place the monitor or any other heavy objects on the cables. If damaged, the cables may cause fire or electric shock.

ADVERSE WEATHER CONDITIONS

It is advisable not to operate the monitor during a heavy thunder storm as the continual breaks in power may cause malfunction. It is also advised not to touch the plug in these circumstances as it may cause electric shock.

CAUTION

INSTALLATION LOCATION

Do not install the monitor where sudden temperature changes may occur, or in humid, dusty or smoky areas as it may cause fire, electric shock or damage. You should also avoid areas where the sun shines directly on the monitor.

DO NOT PLACE THE MONITOR IN A HAZARDOUS POSITION

The monitor may topple and cause injury if not suitably located. Please also ensure that you do not place any heavy objects on the monitor, and that all cables are routed such that children may not pull the cables and possibly cause injury.

MAINTAIN GOOD VENTILATION

Ventilation slots are provided to keep the monitor from overheating. Covering the slots may cause fire. To allow adequate air circulation, place the monitor at least 10 cm (or 4 inches) from any walls. When removing the tilt stand, the ventilation slots on the back side of the monitor can be blocked. This may overheat the monitor and may cause fire or damage. Make sure to allow enough ventilation when removing the tilt stand. Operating the monitor on its back, side, upside down or on a carpet or any other soft material may also cause damage.

DISCONNECT THE CABLES WHEN YOU MOVE THE MONITOR

When you move the monitor, turn off the power switch, unplug the monitor and be sure the signal cable is disconnected. If you do not disconnect them, it may cause fire or electric shock.

UNPLUG THE MONITOR

If the monitor is not in use for a long period of time it is recommended that it is left unplugged to avoid accidents.

HOLD THE PLUG WHEN DISCONNECTING

To disconnect the power cable or signal cable, always pull it by the plug. Never pull on the cable itself as this may cause fire or electric shock.

DO NOT TOUCH THE PLUG WITH WET HANDS

Pulling or inserting the plug with wet hands may cause electric shock.

WHEN YOU INSTALL THE MONITOR ON YOUR COMPUTER

Be sure the computer is strong enough to hold the weight of the monitor, otherwise, you may damage your computer.

CAREFUL! PROTECT YOUR HANDS AND FINGERS

- Be careful not to hurt your fingers or hands when you change the height or the angle.
- Injury can occur if care is not taken to avoid finger contact with the displays base when adjusting the height.

REMARK FOR 24/7 USAGE

This product is not specifically designed for 24/7 usage in all environments.

OTHERS

ERGONOMIC RECOMMENDATIONS

To eliminate eye fatigue, do not operate the monitor against a bright background or in a dark room. For optimal viewing comfort, the monitor should be just below eye level and 40-60 cm (16-24 inches) away from your eyes. When using the monitor over a prolonged time, a ten minute break every hour is recommended as looking at the screen continuously can cause eye strain.

SPECIAL NOTES ON LCD MONITORS

The following symptoms are normal with LCD monitors and do not indicate a problem.

- NOTE**
- When you first turn on the LCD monitor, the picture may not fit in the display area because of the type of computer that is used. In this case, adjust the picture position to the correct position.
 - You may find slightly uneven brightness on the screen depending on the desktop pattern you use.
 - Due to the nature of the LCD screen, an afterimage of the previous screen may remain after switching the image, when the same image is displayed for hours. In this case, the screen can be recovered slowly by changing the image or turning off the Power Switch for some hours.

CUSTOMER SERVICE

- NOTE**
- If you have to return your unit for service and the original packaging has been discarded, please contact your dealer or iiyama service center for advice or replacement packaging.

CLEANING

- WARNING**
- If you drop any materials or liquids such as water into the monitor when cleaning, unplug the power cable immediately and contact your dealer or iiyama service center.

- CAUTION**
- For safety reasons, turn off the power switch and unplug the monitor before you clean it.

- NOTE**
- To protect the LCD panel, do not scratch or rub the screen with a hard object.
 - Never use any of the following strong solvents. These will damage the cabinet and the LCD screen.

Thinner	Spray-type cleaner
Benzine	Wax
Abrasive cleaner	Acid or Alkaline solvent

- Touching the cabinet with any product made from rubber or plastic for a long time may cause degeneration or loss of paint on the cabinet.

CABINET Stains can be removed with a cloth lightly moistened with a mild detergent solvent. Then wipe the cabinet with a soft dry cloth.

LCD Periodic cleaning with a soft dry cloth is recommended.

SCREEN Don't use tissue paper etc. because these will damage the LCD screen.

BEFORE YOU OPERATE THE MONITOR

FEATURES

- ◆ Supports Resolutions up to 3440 × 1440
- ◆ High Contrast 3000:1 (Typical), Advanced Contrast Function Available, Brightness 550cd/m² (Typical)
- ◆ Moving Picture Response Time 0.4ms
- ◆ Supports FreeSync™ Premium Technology
- ◆ Supports HDR400
- ◆ Flicker - Free
- ◆ Blue Light Reducer
- ◆ Digital Character Smoothing
- ◆ 2 × 2W Stereo Speakers
- ◆ Standby Feature
- ◆ VESA Mounting Standard (100mm×100mm) Compliant
- ◆ Keyhole for Security Lock

CHECKING THE CONTENTS OF THE PACKAGE

The following accessories are included in your package. Check to see if they are enclosed with the monitor. If anything is missing or damaged, please contact your local iiyama dealer or regional iiyama office.

- Power Cable*
- USB Cable
- Quick Start Guide
- HDMI Cable
- Stand-Base with a screw
- DisplayPort Cable
- Safety Guide

CAUTION

- * The rating of the Power Cable enclosed in 120V area is 10A/125V. If you are using a power supply higher than this rating, then a power cable with a rating of 10A/250V must be used. However, all guarantees and warranties are void for any problems or damage caused by a power cable not supplied by iiyama. An approved power cable greater or equal to H05VVF, 3G, 0.75mm² must be used.

INSTALLATION

WARNING ■ Before installation, make sure the wall, ceiling or desktop arm is strong enough to hold the necessary weight of the display and the mount.

[WALL MOUNTING]

WARNING ■ When you use with the wall mounting, in consideration of thickness of the mounting stage, tighten the M4 Screws (4pcs) which "L" length is 8mm to fasten the monitor. Using the screw longer than this may cause electric shock or damage because it may contact with the electrical parts inside the monitor.

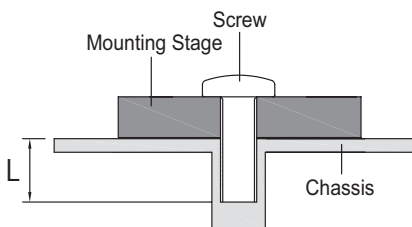

[ROTATING THE MONITOR]

This monitor can only be used in landscape. Do not rotate or operate the monitor in any other orientation than landscape.

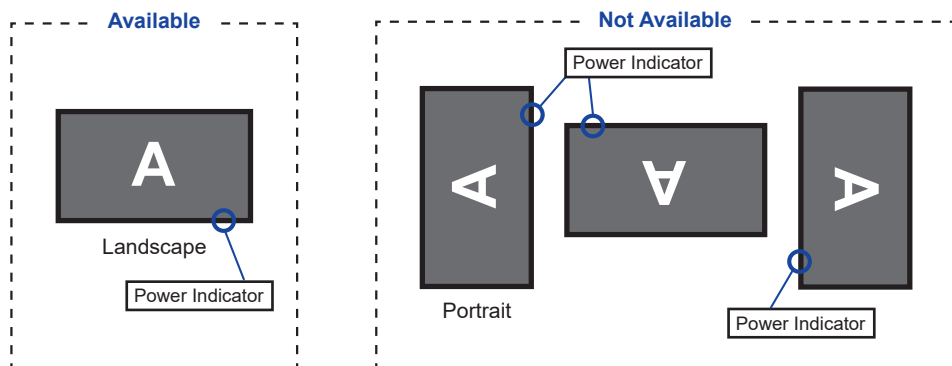

FITTING AND REMOVAL OF BASE

CAUTION

- Put the monitor on a stable surface. The monitor may cause injury or damage if it falls or is dropped.
- Do not give a strong impact to the monitor. It may cause damage.
- Unplug the monitor before removal or installation to avoid an electric shock or a damage.

<Installation>

- ① As shown below, place all the contents taken out from the carton box on a flat surface with the monitor front face down.
- ② Take off the rear cushion and turn the Stand-Neck 90 degrees.

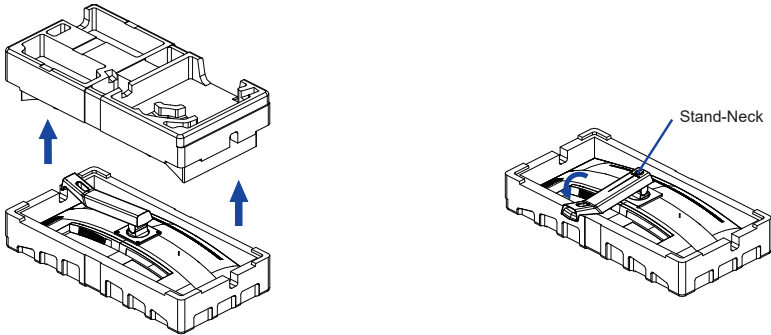

- ③ Install the Stand-Base as shown on the below picture.
- ④ Tighten the 'thumb screw' to secure the Stand-Base to the monitor.

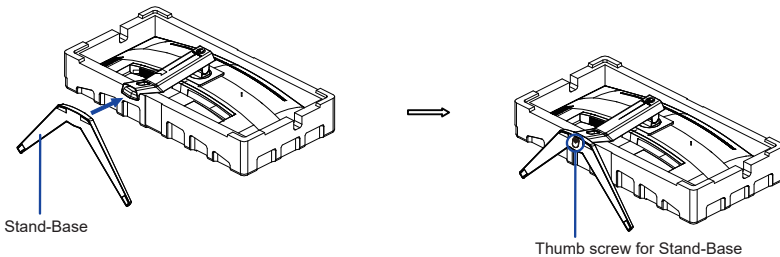

- ⑤ Stand the monitor and then remove the front cushion.

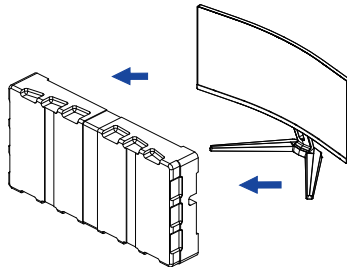

<Removal>

- ① Put the front cushion on a flat surface and place the monitor with face down on it.
- ② Loosen the 'thumb screw' to remove the Stand-Base from the monitor.

CONTROLS AND CONNECTORS

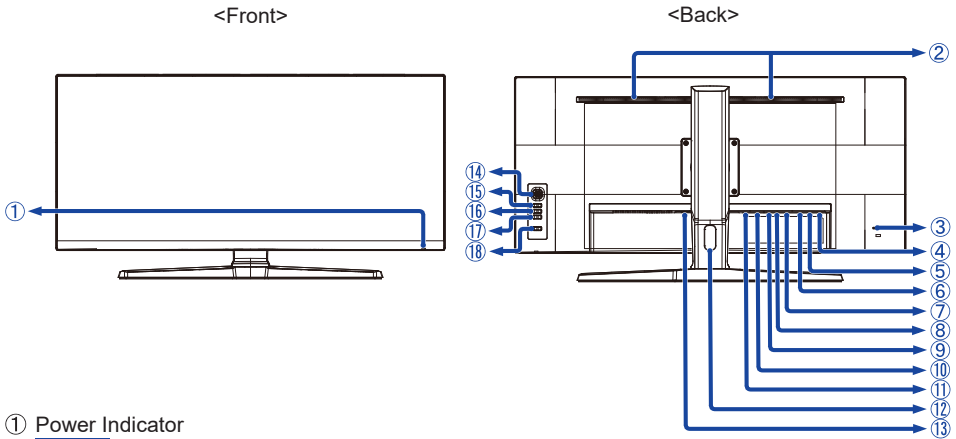

① Power Indicator

NOTE Blue: Normal operation
Orange: Standby mode

② Speakers

③ Keyhole for Security Lock

NOTE You can fasten a security lock and cable to prevent the monitor from being removed without your permission.

④ USB (3.0) Upstream Connector ()

⑤ USB (3.0) Downstream Connector () 5V, 900mA

⑥ USB (3.0) Downstream Connector () 5V, 900mA

⑦ Headphone Connector ()

⑧ DisplayPort Connector (DP1)

⑨ DisplayPort Connector (DP2)

⑩ HDMI Connector (HDMI1)

⑪ HDMI Connector (HDMI2)

⑫ Cable Hole

⑬ AC Connector (~ : Alternating current) (~)

⑭ Navigation Button

Menu

Scroll Up [▲]

Scroll Down [▼]

Left / i-Style Color [◀]

Right / Blue Light Reducer [▶]

⑮ Input Select Button (INPUT) *

⑯ Volume + Button (VOL +) *

⑰ Volume - Button (VOL -) *

⑱ Power Switch ()

* You can skip the Menu items and directly display an option setting screen or an adjustment scale.

CONNECTING YOUR MONITOR

- ① Ensure that both the computer and the monitor are switched off.
- ② Connect the computer to the monitor with the signal cable.
- ③ Connect the computer to the monitor with the USB Cable.
- ④ Connect the Power Cable to the monitor first and then to the power source.
- ⑤ Turn on your monitor and computer.

NOTE

- Make sure that the building installation has a circuit breaker of 120/240V, 20A (maximum).
- The signal cables used for connecting the computer and monitor may vary with the type of computer used. An incorrect connection may cause serious damage to both the monitor and the computer. The cable supplied with the monitor is for a standard connector. If a special cable is required please contact your local iiyama dealer or regional iiyama office.
- The Class I pluggable equipment Type A must be connected to protective earth.
- The socket-outlet shall be installed near the equipment and shall be easily accessible.
- Excessive sound pressure from ear-/headphones can cause hearing damage/hearing loss.

[Example of Connection]

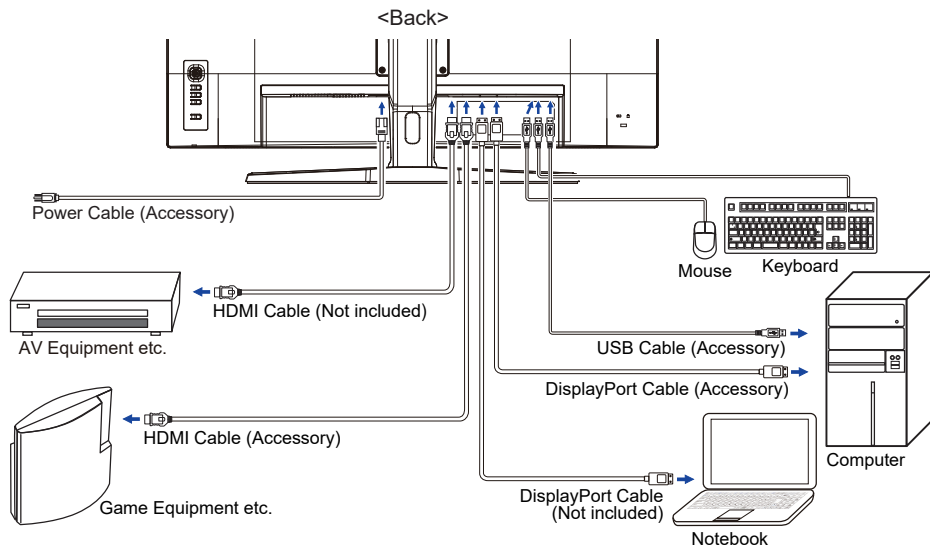

[Collect Cables]

Put the cables through the Cable Hole to bundle them.

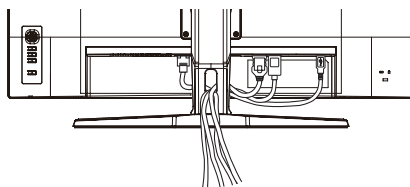

COMPUTER SETTING

■ Signal Timing

Change to the desired signal timing listed on page 28: COMPLIANT TIMING.

ADJUSTING THE HEIGHT AND THE VIEWING ANGLE

- For optimal viewing it is recommended to position yourself directly opposite to the full face of the monitor, then adjust the monitor's height and angle to your own preference.
- Hold the panel so that the monitor does not topple when you change the monitor's height or angle.
- You are able to adjust the monitor's height up to 130mm, 20 degrees upward and 3 degrees downward.

NOTE

- Do not touch the LCD screen when you change the height or the angle. It may cause damage or break the LCD screen.
- Careful attention is required not to pinch your fingers or hands into the moving part of the stand when you change the angle.
- Injury can occur if care is not taken to avoid finger contact with the displays base when adjusting the height.

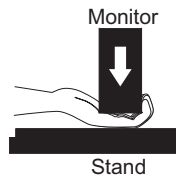
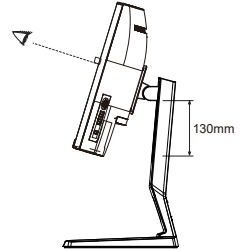
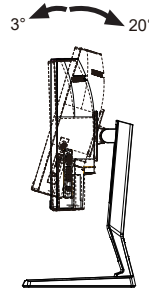

OPERATING THE MONITOR

To create the best picture, your iiyama LCD monitor has been preset at the factory with the COMPLIANT TIMING shown on page 28. You are also able to adjust the picture by following the button operation shown below.

- ① Press the Menu Button to start the On Screen Display feature.



- ② Use the ◀ / ▶ Buttons to select the Menu which contains the item you want to adjust or set and then press the Menu Button.
- ③ Use the ▲ / ▼ Buttons to highlight the desired adjustment / setting icon and then press the Menu Button.
- ④ Use the ◀ / ▶ Buttons again to make the appropriate adjustment or setting and then press the Menu Button.
- ⑤ Press the ◀ Button to leave the menu, and the adjustment or setting you just made would be automatically saved.

For example, to correct for OSD vertical position, select Menu item of Setup Menu and then press the Menu Button. Then, select OSD Vertical Position by using the ▲ / ▼ Buttons. An adjustment scale becomes active after you press the Menu Button.

Use the ◀ / ▶ Buttons to change the OSD vertical position settings. The OSD vertical position of the overall display should be changing accordingly while you are doing this.

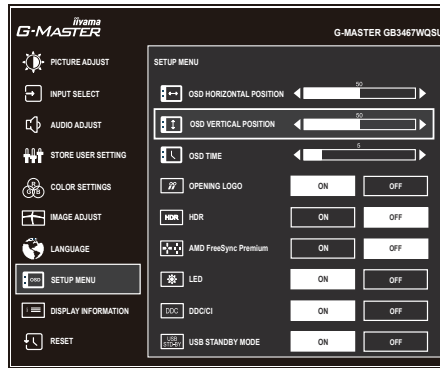

Press the Menu Button and finally the ◀ Button to close the On Screen Display feature. All changes are saved in the memory.

NOTE

- When button operations are aborted during adjustment, On-Screen Display disappears when the time set for the OSD Time has passed. Also, press the ◀ Button to quickly turn off the On-Screen Display.
- Any changes are automatically saved in the memory when the On Screen Display disappears. Turning off the power should be avoided while using the Menu.
- All adjustments have only one setting which applies to all signal timings.

ADJUSTMENT MENU CONTENTS



Picture Adjust *1

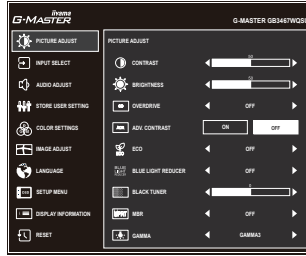

Adjustment Item	Problem / Option	Button to Press
Contrast	Too dark Too bright	
Brightness *2	Too dull Too intense	
Overdrive	Off / 1 / 2 / 3 / 4 / 5 It will improve the gray level response time of the LCD panel. A higher level results in a faster response time.	
Adv. Contrast	On	Increased Contrast Ratio
	Off	Typical Contrast Ratio
Eco	Off	Normal
	Mode1	Brightness of back-light is reduced.
	Mode2	Brightness of back-light is reduced more than Mode1.
Blue Light Reducer Direct	Off	Typical
	Mode1	Blue light is reduced.
	Mode2	Blue light is reduced more than Mode1.
	Mode3	Blue light is reduced more than Mode2.
Black Tuner	From -5 to +5 You can adjust Dark shades.	
MBR *3	Off, 1 - 7 Improve the moving picture response time of the LCD panel.	
Gamma	Gamma1	
	Gamma2	
	Gamma3	

*1 The availability of each item depends on which item is activated. See page 23 Function Correlation Matrix for more details.

*2 Adjust the Brightness when you are using the monitor in a dark room and feel the screen is too bright.

*3 MBR is available only when the refresh rate is higher than 75Hz.

Direct

You can skip the Menu items and directly display an option setting screen by using the following button operations.

- Blue Light Reducer : Press the ► Button when the Menu is not displayed.



Input Select

Direct

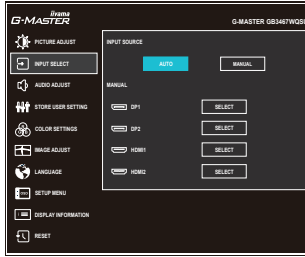

Adjustment Item		Option	
Input Source	Auto		Search for an available input source and select automatically.
	Manual	DP1	Select the Digital (DisplayPort1) input.
		DP2	Select the Digital (DisplayPort2) input.
		HDMI1	Select the Digital (HDMI1) input.
		HDMI2	Select the Digital (HDMI2) input.
<p>NOTE Input source is fixed, not selected automatically when HDMI and DisplayPort which are selected.</p>			

Direct

You can skip the Menu items and directly display an option setting screen by using the following button operations.



- Input Select : Press the INPUT button when the Menu is not displayed.



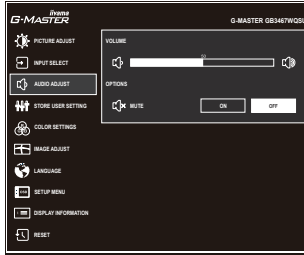

Audio Adjust

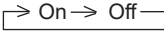

Adjustment Item	Problem / Option	Button to Press
Volume Direct	Too soft Too loud	 
Mute	On	Turn off the sound temporarily.
	Off	Return the sound volume to the previous level.
NOTE Mute On and Off are switched as follows by pressing the ◀/▶ Buttons successively. 		

Direct

You can skip the Menu items and directly display an adjustment scale by using the following button operations.

- Volume : Press the VOL + / VOL - Button when the Menu is not displayed.



Store User Setting

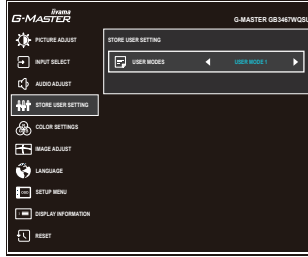

Adjustment Item	Option	
User Modes	User Mode 1	Save the settings of the screen adjustment.
	User Mode 2	Save the settings of the screen adjustment.
	User Mode 3	Save the settings of the screen adjustment.

NOTE

You can memorize your customized monitor settings.

The following settings can be memorized:

Contrast, Brightness, Overdrive, Adv. Contrast, Eco, Black Tuner, MBR, Gamma, Volume, Mute, Color Settings, Sharp and Soft, Video Mode Adjust



Color Settings *

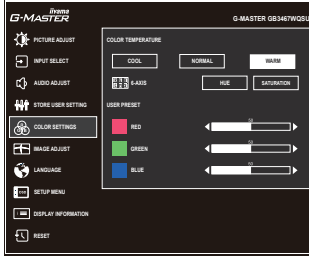

Adjustment Item	Problem / Option		Button to Press	
Color Temperature	Cool	Cool color		
	Normal	Normal color		
	Warm	Warm color		
6-Axis	Hue	Red	Too weak Too strong	
		Yellow		
		Green		
		Cyan		
		Blue		
		Magenta		
	Saturation	Red	Too weak Too strong	
		Yellow		
		Green		
		Cyan		
		Blue		
		Magenta		
User Preset	Red	Too weak Too strong	 	
	Green			
	Blue			

* Disabled when Blue Light Reducer or HDR is active.

Image Adjust

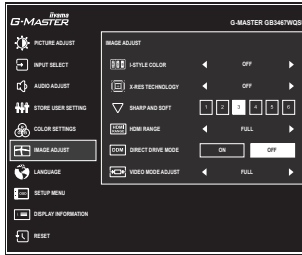

Adjustment Item	Option	Button to Press
i-Style Color *3	Off	Return to a state set by color adjustment except i-Style Color.
	Standard	For general windows environment and monitor default setting
	Sport Game	For Sports game environment
	FPS Game	For FPS game environment
	Strategy Game	For Strategy game environment
	Text	For text editing and viewing in a word processing environment
	User Mode 1	Applies customized monitor settings.
	User Mode 2	Applies customized monitor settings.
	User Mode 3	Applies customized monitor settings.
X-Res Technology *1,3	Off	Normal
	Soft	Enhance the picture edge.
	Middle	Enhance the picture edge more than the Soft option.
	Hard	Enhance the picture edge more than the Middle option.
Sharp and Soft	1 2 3 4 5 6 You can change the picture quality from 1 to 6 (sharp to soft). Press the ► Button to change the picture quality in numerical order. Press the ◀ Button to change the picture quality in reverse numerical order.	
HDMI Range *2	Full	For full-range color scale signal
	Limited	For limited color scale signal
Direct Drive Mode *3	On	Reduce the input-lag.
	Off	Typical
NOTE	Changing Resolution and Refresh rate or turning Power Off/On might disable the Direct Drive Mode function.	

Direct

You can skip the Menu items and directly display an option setting screen by using the following button operations.

- i-Style Color : Press the ◀ Button when the Menu is not displayed.



Image Adjust

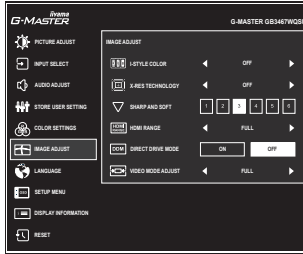

Adjustment Item

Option

Video Mode Adjust *3

Full	Expansion display
Aspect	Expansion display of Aspect
Dot by Dot *4	Display the picture dot by dot.
17inch *4	Display the picture as 17 inch screen (5 : 4).
19inch *4	Display the picture as 19 inch screen (5 : 4).
19.5inch *4	Display the picture as 19.5 inch screen (16 : 9).
21.5inch *4	Display the picture as 21.5 inch screen (16 : 9).
23inch *4	Display the picture as 23 inch screen (16 : 9).
23.6inch *4	Display the picture as 23.6 inch screen (16 : 9).
23.8inch *4	Display the picture as 23.8 inch screen (16 : 9).
24inch *4	Display the picture as 24 inch screen (16 : 9).
24.5inch *4	Display the picture as 24.5 inch screen (16 : 9).
27inch *4	Display the picture as 27 inch screen (16 : 9).

*1 Disabled when HDR is active.

*2 Available for HDMI input only.

*3 The availability of each item depends on which item is activated. See page 23 Function Correlation Matrix for more details.

*4 Available only at resolutions 1920 × 1080 or less.





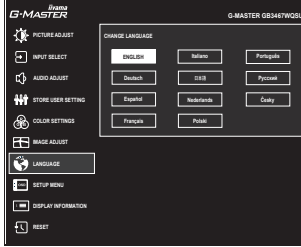

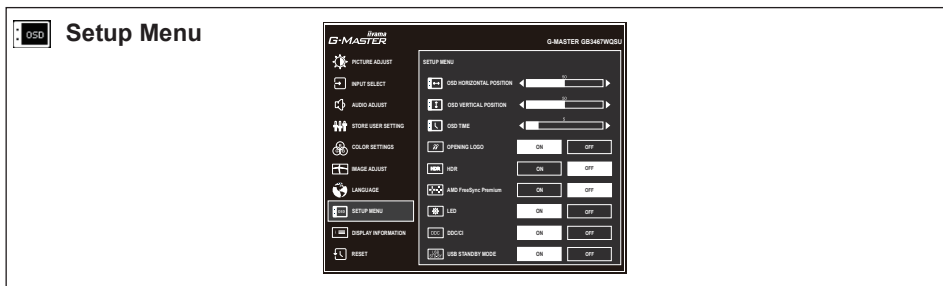

Language



Adjustment Item	Option			
Language	English	English	Nederlands	Dutch
	Deutsch	German	Polski	Polish
	Español	Spanish	Português	Portuguese
	Français	French	Русский	Russian
	Italiano	Italian	Česky	Czech
	日本語	Japanese		



Adjustment Item	Problem / Option	Button to Press
OSD Horizontal Position	OSD is too left OSD is too right	 
OSD Vertical Position	OSD is too low OSD is too high	 
OSD Time	You can set the OSD display duration time between 5 and 30 seconds.	 
Opening Logo	On	G-MASTER Logo is displayed when the monitor is turned on.
	Off	G-MASTER Logo is not displayed when the monitor is turned on.
HDR *	On	For HDR (High Dynamic Range) signal
	Off	For normal signal
FreeSync Premium *	On	Enable the FreeSync function.
	Off	The FreeSync function is turned off.
LED	On	The Power Indicator is turned On.
	Off	The Power Indicator is turned Off.
NOTE Turn Off the Power Indicator when you are bothered by the light.		
DDC/CI	On	DDC/CI is On.
	Off	DDC/CI is Off.
USB Standby Mode	On	The USB hub enters into the standby mode in synchronization with the monitor.
	Off	The USB hub remains activated if the monitor enters into the standby mode.

* The availability of each item depends on which item is activated. See page 23 Function Correlation Matrix for more details



Display Information

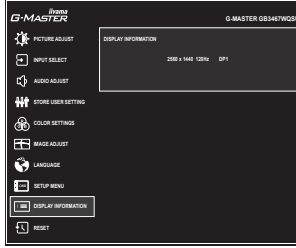

Displays information regarding the current input signal coming from the graphic card in your computer.

NOTE See your graphic card user guide for more information about changing the resolution and refresh.



Reset



Adjustment Item	Option
Yes	Factory-preset data is restored.

- **Lock Mode**

<OSD>

If you turn on the monitor with holding down the MENU Button on the monitor while the monitor is off, the OSD button operations will be locked / unlocked.

<Power / OSD>

If you keep pressing the MENU Button on the monitor for 10 seconds when the Menu is not displayed, the Power / OSD button operations will be locked / unlocked.

■ Function Correlation Matrix

Selected item Active Item		Picture Adjust									Color			Image Adjust					Setup		
		Contrast	Brightness	Overdrive	Adv. Contrast	Eco	Blue Light Reducer	Black Tuner	MBR	Gamma	Cool / Normal / Warm	Hue / Saturation	R/G/B	i-Style Color		X-Res	Direct Drive	Video Mode		HDR	Free Sync
														Pre-set	User mode			Full / Aspect	Dot by dot / Size		
Picture adjust	Adv. Contrast	-	-	✓	-	-	✓	-	✓	✓	✓	✓	✓	✓	✓	✓	✓	✓	-	-	
	Eco	✓	-	✓	-	-	✓	-	✓	✓	✓	✓	✓	✓	✓	✓	✓	✓	-	✓	
	Blue Light Reducer	✓	✓	✓	-	-	✓	-	✓	✓	✓	✓	✓	✓	✓	✓	✓	✓	-	✓	
	Black Tuner	✓	✓	✓	✓	✓	✓	✓	✓	✓	✓	✓	✓	✓	✓	✓	✓	✓	✓	✓	
	MBR	✓	-	-	-	-	-	-	✓	-	-	-	✓	✓	✓	✓	✓	✓	-	-	
Image adjust	i-Style Pre-set	-	-	-	-	-	-	-	✓	✓	✓	✓	✓	✓	✓	-	✓	✓	-	-	
	Direct Drive On	✓	✓	✓	✓	✓	✓	✓	✓	✓	✓	✓	✓	✓	✓	✓	✓	✓	✓	✓	
	Direct Drive Off	✓	✓	-	✓	✓	✓	✓	✓	✓	✓	✓	✓	✓	✓	✓	✓	✓	✓	-	
	Video mode Full / Aspect	✓	✓	✓	✓	✓	✓	✓	✓	✓	✓	✓	✓	✓	✓	✓	✓	✓	✓	✓	
	Video mode Dot by dot / Size	✓	✓	-	✓	✓	✓	✓	-	✓	✓	✓	✓	✓	✓	-	✓	✓	✓	-	
Setup	HDR	✓	✓	✓	-	✓	-	-	-	-	-	-	-	✓	-	✓	✓	-	✓		
	FreeSync	✓	✓	✓	-	✓	✓	✓	-	✓	✓	✓	✓	✓	✓	✓	✓	-	✓		

✓ : Available

- : Not available

STANDBY FEATURE

This product features the standby function. When activated, it automatically reduces unnecessary power consumption of the monitor when your computer is not in use.

There is a standby step the monitor takes as described below. The standby function, including any timer settings is configured by the operating system. Check your operating system manual for information on how this can be configured.

■ Standby Mode

When the video signal from the computer is off, the monitor enters into Standby Mode which reduces the power consumption to less than 0.5W*. The screen becomes dark, and the power indicator turns to orange. From Standby Mode, the image reappears in several seconds when either the keyboard or the mouse are touched again.

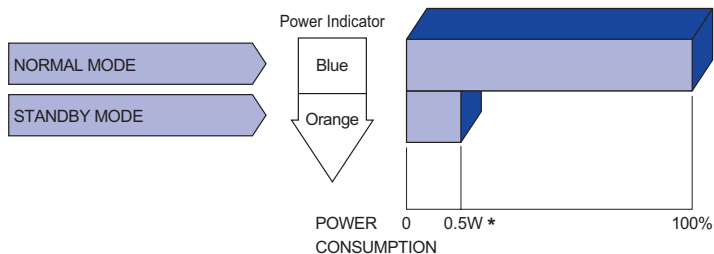

* When the "USB Standby Mode" of "Setup Menu" is : On

TROUBLE SHOOTING

If the monitor fails to operate correctly, please follow the steps below for a possible solution.

1. Perform the adjustments described in OPERATING THE MONITOR, depending on the problem you have. If the monitor does not get a picture, skip to 2.
2. Consult the following items if you cannot find an appropriate adjustment item in OPERATING THE MONITOR or if the problem persists.
3. If you are experiencing a problem which is not described below or you cannot correct the problem, discontinue using the monitor and contact your dealer or iiyama service center for further assistance.

Problem	Check
① The picture does not appear. (Power indicator does not light up.) (Power indicator is blue.) (Power indicator is orange.)	<input type="checkbox"/> The Power Cable is firmly seated in the socket. <input type="checkbox"/> The Power Switch is turned ON. <input type="checkbox"/> The AC socket is live. Please check with another piece of equipment. <input type="checkbox"/> If the blank screen saver is in active mode, touch the keyboard or the mouse. <input type="checkbox"/> Increase the Contrast and/or Brightness. <input type="checkbox"/> The computer is ON. <input type="checkbox"/> The Signal Cable is properly connected. <input type="checkbox"/> The signal timing of the computer is within the specification of the monitor. <input type="checkbox"/> If the monitor is in standby mode, touch the keyboard or the mouse. <input type="checkbox"/> The computer is ON. <input type="checkbox"/> The Signal Cable is properly connected. <input type="checkbox"/> The signal timing of the computer is within the specification of the monitor.
② The screen is not synchronized.	<input type="checkbox"/> The Signal Cable is properly connected. <input type="checkbox"/> The signal timing of the computer is within the specification of the monitor.
③ The screen position is not in the center.	<input type="checkbox"/> The signal timing of the computer is within the specification of the monitor.
④ The screen is too bright or too dark.	<input type="checkbox"/> The video output level of the computer is within the specification of the monitor.
⑤ The screen is shaking.	<input type="checkbox"/> The power voltage is within the specification of the monitor. <input type="checkbox"/> The signal timing of the computer is within the specification of the monitor.
⑥ No sound.	<input type="checkbox"/> The audio equipment (computer etc.) is ON. <input type="checkbox"/> The Volume is turned up. <input type="checkbox"/> The Mute is OFF. <input type="checkbox"/> The audio output level of the audio equipment is within the specification of the monitor.
⑦ The sound is too loud or too quiet.	<input type="checkbox"/> The audio output level of the audio equipment is within the specification of the monitor.

RECYCLING INFORMATION

For better environment protection please don't dispose your monitor.
Please visit our web site: www.iiyama.com for monitor recycling.

APPENDIX

Design and specifications are subject to change without prior notice.

SPECIFICATIONS

Size Category		34"
LCD Panel	Panel technology	VA
	Size	Diagonal: 34" (86.4cm)
	Pixel pitch	0.232mm H × 0.232mm V
	Brightness	550cd/m ² (Typical)
	Contrast ratio	3000 : 1 (Typical), Advanced Contrast Function Available
	Viewable angle	Right / Left : 89 degrees each, Up / Down: 89 degrees each (Typical)
	MPRT	0.4ms
Display Colors		Approx. 16.7M
Sync Frequency		HDMI: Horizontal: 30.0-160.0kHz Vertical: 48-120Hz (1920 × 1080 or less) 48-100Hz (3440 × 1440) DisplayPort: Horizontal: 30.0-250.0kHz Vertical: 48-165Hz
Native Resolution		3440 × 1440, 4.9 MegaPixels
Supported max. resolution		HDMI: 3440 × 1440 100Hz, 1920 × 1080 120Hz DisplayPort: 3440 × 1440 165Hz
Input Connector		HDMI × 2, DisplayPort × 2
Input Video Signal		HDMI, DisplayPort
USB Standard		USB3.0 (DC5V, 900mA) × 4
Number of USB Ports Connector shape		1 Upstream : Series B 4 Downstream : Series A
Headphone Connector		ø 3.5mm mini jack (Stereo)
Speakers		2W × 2 (Stereo speakers)
Maximum Screen Size		797.22mm W × 333.72mm H / 31.4" W × 13.1" H
Power Source		100-240VAC, 50/60Hz, 1.5A
Power Consumption*		66W typical (38W typical in factory configuration) Standby mode: 0.5W maximum, Off mode: 0.3W maximum
Dimensions / Net Weight		809.5 × 425.0 - 555.0 × 275.0mm / 31.9 × 16.7 - 21.9 × 10.8" (W×H×D) 8.7kg / 19.2lbs
Tilt Angle		Upward: 20°, Downward: 3°
Environmental Considerations		Operating: Temperature 5 to 35°C / 41 to 95°F Humidity 10 to 80% (No condensation) Storage: Temperature -20 to 60°C / -4 to 140°F Humidity 5 to 85% (No condensation)
Approvals		CE, UKCA, TÜV-Bauart, EAC, VCCI, PSE

NOTE

* When the "USB Standby Mode" of "Setup Menu" is : On

DIMENSIONS

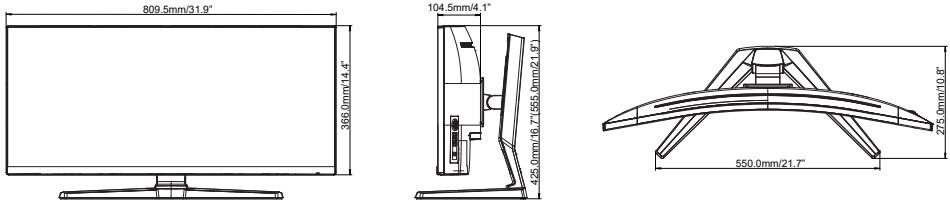

() : Maximum adjustment range

COMPLIANT TIMING

Video Mode	Horizontal Frequency	Vertical Frequency	Dot Clock
800 × 600	37.879kHz	60.317Hz	40.000MHz
	46.875kHz	75.000Hz	49.500MHz
1024 × 768	48.363kHz	60.004Hz	65.000MHz
	60.023kHz	75.029Hz	78.750MHz
1280 × 1024	63.981kHz	60.020Hz	108.000MHz
	79.976kHz	75.025Hz	135.000MHz
1920 × 1080	67.500kHz	60.000Hz	148.500MHz
	135.000kHz	120.000Hz	297.000MHz
3440 × 1440	88.860kHz	60.000Hz	319.896MHz
	151.000kHz	100.000Hz	543.600MHz
	244.370kHz	165.000Hz	879.714MHz

*1

*2

*1 Only HDMI input.

*2 Only DisplayPort input.

Console	1080p (1920 × 1080)	1440p (2560 × 1440)	2160p (3840 × 2160)
PS5	60 / 120Hz	—	60Hz
Xbox Series X/S	60 / 120Hz	—	60Hz