

USER MANUAL

G-MASTER

LCD Monitor

ENGLISH

G-MASTER GC2480HSU

Thank you very much for choosing the iiyama LCD monitor.

We recommend that you take a few minutes to read this comprehensive manual carefully before installing and switching on the monitor. Please keep this manual in a safe place for your future reference.



Dear user, we congratulate you on the purchase of your iiyama LCD.

For details on warranty and locally used pixel policies that apply directly after installation of your product please check the iiyama website.

To report a fault, please contact your local support centre found at <https://iiyama.com>

Things to check before you call the iiyama information line

- | if the power cable is connected securely and turned on?
- | if the display has been turned on?
- | if the signal cable is connected securely and the correct input selected?
- | if the computer has been restarted with the display connected?
- | if the graphics card is correctly installed with the latest drivers possible?
- | if the correct native resolution has been selected via 'Display Properties'?
- | If the R/G/B signal configuration is correct?
- | if the displays On Screen Menu is shown?
- | if the correct brightness and contrast settings have been set?
- | if given display tolerances and compatibility have been considered?
- | if via the On Screen Menu you have performed a Factory Reset/Recall?

Before reporting the screen defect, please prepare the following information/evidence:

- | model number *
- | purchase receipt and serial number *
- | name and address for collection
- | telephone/fax number, for availability during the day
- | convenient collection date (date, time)
- | short description of the defect

Important Note:

If there is no fault found in the collected equipment after inspection, the transferring party shall incur charges for transport and administration.

If you have checked all of the above and there is still no picture, call our information line for assistance in your country.

Feedback on health and safety issues

If you have any health and safety concerns or questions about the product (including when using the product), please contact iiyama support through our website. You can also contact us by calling +31 204460404. After receiving your feedback, we will ask the responsible unit to handle it as soon as possible and a dedicated person will get back to you. Your feedback will also be recorded and incorporated into our evaluation for improvements

* see the identification plate on the back of the case.

CE MARKING DECLARATION OF CONFORMITY

This LCD monitor complies with the requirements of the EC/EU Directive 2014/30/EU "EMC Directive", 2014/35/EU "Low Voltage Directive", 2009/125/EC "ErP Directive" and 2011/65/EU "RoHS Directive".

The electro-magnetic susceptibility has been chosen at a level that gives correct operation in residential areas, business and light industrial premises and small-scale enterprises, inside as well as outside of the buildings. All places of operation are characterised by their connection to the public low voltage power supply system.

IYAMA CORPORATION: Wijkmeerstraat 8, 2131 HA Hoofddorp, The Netherlands

Model No. : PL2480HS



We recommend recycling of used product. Please contact your dealer or iiyama service center. Recycle information is obtained via the Internet, using the address: <https://iiyama.com>

You can access the Web page of different countries from there.

- We reserve the right to change specifications without notice.
- All trademarks used in this user manual are the property of their respective owners.
- The terms HDMI and HDMI High-Definition Multimedia Interface, and the HDMI Logo are trademarks or registered trademarks of HDMI Licensing Administrator, Inc. in the United States and other countries.
- Eprel registration number GC2480HSU-B1: 2100619

TABLE OF CONTENTS

| | |
|---|----|
| FOR YOUR SAFETY..... | 1 |
| SAFETY PRECAUTIONS..... | 1 |
| SPECIAL NOTES ON LCD MONITORS..... | 3 |
| CUSTOMER SERVICE..... | 3 |
| CLEANING..... | 4 |
| BEFORE YOU OPERATE THE MONITOR..... | 5 |
| FEATURES..... | 5 |
| CHECKING THE CONTENTS OF THE PACKAGE..... | 5 |
| USING ARM OR STAND..... | 6 |
| FITTING AND REMOVAL OF BASE..... | 8 |
| CONTROLS AND CONNECTORS..... | 10 |
| CONNECTING YOUR MONITOR..... | 11 |
| COMPUTER SETTING..... | 12 |
| ADJUSTING THE VIEWING ANGLE..... | 12 |
| OPERATING THE MONITOR..... | 13 |
| ADJUSTMENT MENU CONTENTS..... | 14 |
| STANDBY FEATURE..... | 25 |
| TROUBLE SHOOTING..... | 26 |
| RECYCLING INFORMATION..... | 27 |
| APPENDIX..... | 28 |
| SPECIFICATIONS : G-MASTER GC2480HSU-B1..... | 28 |
| DIMENSIONS..... | 29 |
| COMPLIANT TIMING..... | 29 |

FOR YOUR SAFETY

SAFETY PRECAUTIONS

WARNING

STOP OPERATING THE MONITOR WHEN YOU SENSE TROUBLE

If you notice any abnormal phenomena such as smoke, strange sounds or fumes, unplug the monitor and contact your dealer or iiyama service center immediately. Further use may be dangerous and can cause fire or electric shock.

NEVER REMOVE THE CABINET

High voltage circuits are inside the monitor. Removing the cabinet may expose you to the danger of fire or electric shock.

DO NOT PUT ANY OBJECT INTO THE MONITOR

Do not put any solid objects or liquids such as water into the monitor. In case of an accident, unplug your monitor immediately and contact your dealer or iiyama service center. Using the monitor with any object inside may cause fire, electric shock or damage.

INSTALL THE MONITOR ON A FLAT, STABLE SURFACE

The monitor may cause an injury if it falls or is dropped.

DO NOT USE THE MONITOR NEAR WATER

Do not use where water may be splashed or spilt onto the monitor as it may cause fire or electric shock.

OPERATE UNDER THE SPECIFIED POWER SUPPLY

Be sure to operate the monitor only with the specified power supply. Use of an incorrect voltage will cause malfunction and may cause fire or electric shock.

PROTECT THE CABLES

Do not pull or bend the power cable and signal cable. Do not place the monitor or any other heavy objects on the cables. If damaged, the cables may cause fire or electric shock.

ADVERSE WEATHER CONDITIONS

It is advisable not to operate the monitor during a heavy thunder storm as the continual breaks in power may cause malfunction. It is also advised not to touch the plug in these circumstances as it may cause electric shock.

CAUTION

INSTALLATION LOCATION

Do not install the monitor where sudden temperature changes may occur, or in humid, dusty or smoky areas as it may cause fire, electric shock or damage. You should also avoid areas where the sun shines directly on the monitor.

DO NOT PLACE THE MONITOR IN A HAZARDOUS POSITION

The monitor may topple and cause injury if not suitably located. Please also ensure that you do not place any heavy objects on the monitor, and that all cables are routed such that children may not pull the cables and possibly cause injury.

CAUTION

MAINTAIN GOOD VENTILATION

Ventilation slots are provided to keep the monitor from overheating. Covering the slots may cause fire. To allow adequate air circulation, place the monitor at least 10cm (or 4 inches) from any walls.

When removing the tilt stand, the ventilation slots on the back side of the monitor can be blocked. This may overheat the monitor and may cause fire or damage. Make sure to allow enough ventilation when removing the tilt stand. Operating the monitor on its back, side, upside down or on a carpet or any other soft material may also cause damage.

DISCONNECT THE CABLES WHEN YOU MOVE THE MONITOR

When you move the monitor, turn off the power switch, unplug the monitor and be sure the signal cable is disconnected. If you do not disconnect them, it may cause fire or electric shock.

UNPLUG THE MONITOR

If the monitor is not in use for a long period of time it is recommended that it is left unplugged to avoid accidents.

HOLD THE PLUG WHEN DISCONNECTING

To disconnect the power cable or signal cable, always pull it by the plug. Never pull on the cable itself as this may cause fire or electric shock.

DO NOT TOUCH THE PLUG WITH WET HANDS

Pulling or inserting the plug with wet hands may cause electric shock.

WHEN YOU INSTALL THE MONITOR ON YOUR COMPUTER

Be sure the computer is strong enough to hold the weight of the monitor, otherwise, you may damage your computer.

REMARK FOR 24/7 USAGE

This product is not specifically designed for 24/7 usage in all environments.

REMARK SPECIFIC TO DESKTOP USE

This product is designed for desktop use, not for digital signage (electronic signboard) applications such as ceiling hanging or wall mounting.

DO NOT TILT THE MONITOR DOWNWARD TOO FAR

To avoid potential screen damage such as LCD panel peeling from the bezel, ensure that the monitor does not tilt downward beyond its adjustable range.

DO NOT USE ALCOHOL OR DISINFECTANTS ON THE MONITOR

Do not spray alcohol or disinfectants directly onto the monitor or use them near the monitor. Also, do not wipe the monitor with a cloth or sheet that contains alcohol or disinfectants. These may cause discoloration, deterioration, or cracking of the cabinet, damage to the surface treatment of the LCD panel, and deterioration of components.

OTHERS

ERGONOMIC RECOMMENDATIONS

To eliminate eye fatigue, do not operate the monitor against a bright background or in a dark room. For optimal viewing comfort, the monitor should be just below eye level and 40-60 cm (16-24 inches) away from your eyes. When using the monitor over a prolonged time, a ten minute break every hour is recommended as looking at the screen continuously can cause eye strain.

SPECIAL NOTES ON LCD MONITORS

The following symptoms are normal with LCD monitors and do not indicate a problem.

NOTE

- When you first turn on the LCD monitor, the picture may not fit in the display area because of the type of computer that is used. In this case, adjust the picture position to the correct position.
- You may find slightly uneven brightness on the screen depending on the desktop pattern you use.
- Due to the nature of the LCD screen, an afterimage of the previous screen may remain after switching the image, when the same image is displayed for hours. In this case, the screen can be recovered slowly by changing the image or turning off the Power Switch for some hours.

CUSTOMER SERVICE

NOTE

- If you have to return your unit for service and the original packaging has been discarded, please contact your dealer or iiyama service center for advice or replacement packaging.

CLEANING

WARNING

- If you drop any materials or liquids such as water into the monitor when cleaning, unplug the power cable immediately and contact your dealer or iiyama service center.
- For safety reasons, turn off the power switch and unplug the monitor before you clean it.

CAUTION

- Do not spray alcohol or disinfectants directly onto the monitor or use them near the monitor. Also, do not wipe the monitor with a cloth or sheet that contains alcohol or disinfectants. These may cause discoloration, deterioration, or cracking of the cabinet, damage to the surface treatment of the LCD panel, and deterioration of components.
- To avoid potential damage on the monitor (LCD panel/cabinet/connector terminals) or accessories, never use the following strong solvents or cleaning sheets. These may cause discoloration, deterioration, or cracking of the cabinet, damage to the surface treatment of the LCD panel, and deterioration of components.

| | |
|---|-----------------------------|
| Benzine | Hypochlorous acid water |
| Thinner | Acidic or alkaline solvents |
| Alcohol | Wax |
| Bleach | Abrasives |
| Peroxide | Office equipment cleaner |
| Acetone | Glass cleaner |
| Methylene chloride | Tissue paper |
| Toluene | Wet tissue |
| Ammonia | Chemical cloth |
| Sodium hypochlorite solution (Chlorine bleach) | Cleaning paper |
| | etc. |

NOTE

- To protect the LCD panel, do not scratch or rub the screen with a hard object.
- Do not leave the LCD panel wet. If water droplets or the like get on it, immediately wipe it off with a dry, soft cloth. Leaving it on may cause discoloration or stains on the LCD panel. In addition, if moisture gets inside the monitor, it may cause damage.
- Touching the cabinet with any product made from rubber or plastic for a long time may cause degeneration or loss of paint on the cabinet.

Regular care

Gently wipe the cabinet with a soft, dry and clean cloth. If your monitor is particularly dirty, soak the cloth in a mild detergent thoroughly diluted with water, wring it out tightly, and then wipe the dirt off. Then immediately wipe it with a soft, dry cloth.

Alcohol disinfection

Alcohol disinfection may cause discoloration, deterioration, or cracking of the cabinet, damage to the surface treatment of the LCD panel, and deterioration of components. Instead, we recommend disinfecting your hands away from the monitor before and after use.

If you absolutely must disinfect the monitor with alcohol, please understand above warnings and cautions in advance. Also, avoid frequent alcohol disinfection.

BEFORE YOU OPERATE THE MONITOR

FEATURES

- ◆ Supports Resolutions up to 1920 × 1080
- ◆ High Contrast 3000:1 (Typical), Adv. Contrast Function Available / Brightness 300cd/m² (Typical)
- ◆ Supports AMD FreeSync™ technology
- ◆ Flicker - Free
- ◆ Moving Picture Response Time 0.5ms
- ◆ Blue Light Reducer
- ◆ Digital Character Smoothing
- ◆ 2 × 2W Stereo Speakers
- ◆ Standby Feature (VESA DPMS Compliant)
- ◆ VESA Mounting Standard (100mm×100mm) Compliant
- ◆ Keyhole for Security Lock

CHECKING THE CONTENTS OF THE PACKAGE

The following accessories are included in your package. Check to see if they are enclosed with the monitor. If anything is missing or damaged, please contact your local iiyama dealer or regional iiyama office.

- | | | |
|----------------|---------------------------|----------------|
| ■ Power Cable* | ■ HDMI Cable | ■ USB Cable |
| ■ Satbd-Neck | ■ Stand-Base with a screw | ■ Cable-Holder |
| ■ Safety Guide | ■ Quick Start Guide | |

CAUTION

- * All guarantees and warranties are void for any problems or damage caused by a power cable not supplied by iiyama.
An approved power cable greater or equal to H05VVF, 3G, 0.75mm² must be used.

USING ARM OR STAND

CAUTION

- This product is designed for desktop use, not for digital signage (electronic signboard) applications such as ceiling hanging or wall mounting.
- Before installation, make sure the display arm or desk arm stand is strong enough to hold the necessary weight of the monitor and the mount.
- The monitor angle should be within 22° upward and 4° downward. This product cannot be used facing upward or downward beyond this range.
- If the monitor is used (installed) at an angle more than 4° downward, the LCD may peel off from the bezel and fall, resulting in damage. In addition, such cases will not be covered by support or warranty.

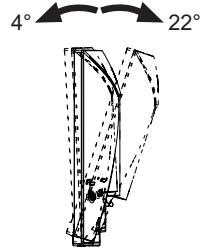

[DISPLAY ARM OR DESK ARM STAND]

CAUTION

- When you use with the display arm or desk arm stand, in consideration of thickness of the mounting stage, tighten the M4 Screws (4pcs) which "L" length is 7mm to fasten the monitor. Using the screw longer than this may cause electric shock or damage because it may contact with the electrical parts inside the monitor.

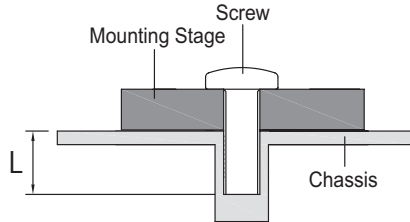

< ROTATING THE DISPLAY >

The monitor is designed to be compatible in landscape mode.

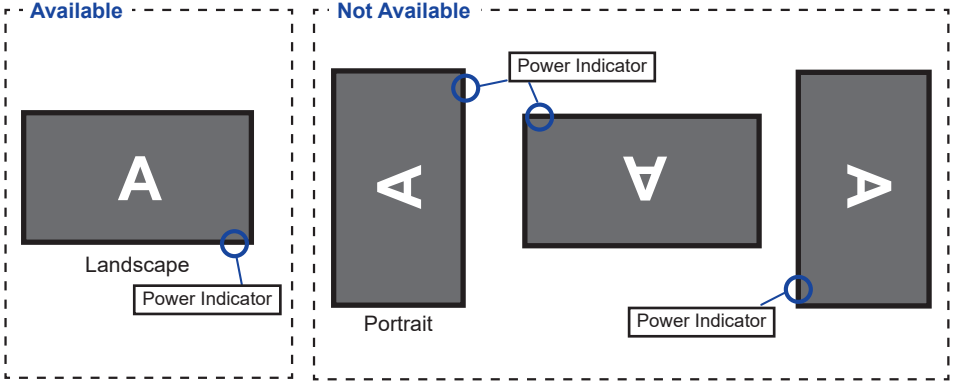

FITTING AND REMOVAL OF BASE

- CAUTION**
- Put the monitor on a stable surface. The monitor may cause injury or damage if it falls or is dropped.
 - Do not give a strong impact to the monitor. It may cause damage.
 - Unplug the monitor before removal or installation to avoid an electric shock or a damage.

<Installation>

- ① As shown below, place all the contents taken out from the carton box on a flat surface with the monitor front face down.
- ② Take off the rear cushion, Stand-Neck, Stand-Base, and Cable-Holder.

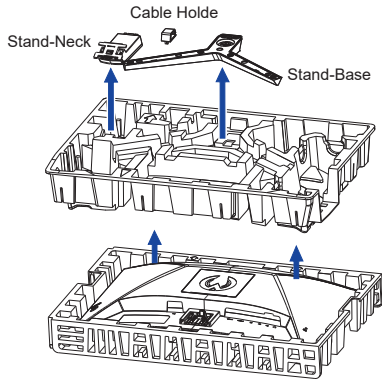

- ③ Place the Cable Holder.

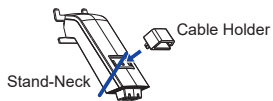

NOTE The cable holder cannot be removed after installation.

- ④ Hold the monitor and install the Stand-Neck to the monitor until it clicks to secure.

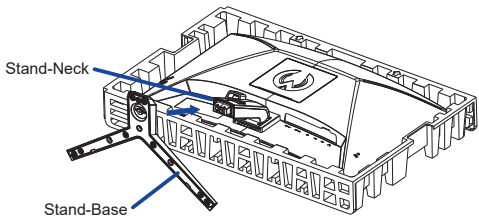

- ⑤ Use the 'thumb screw' provided to secure the Stand-Base to the Stand-Neck.

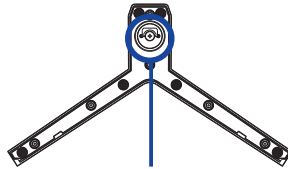

Thumb screw for Stand-Base fixing

- ⑥ Stand the monitor and then remove the front cushion.

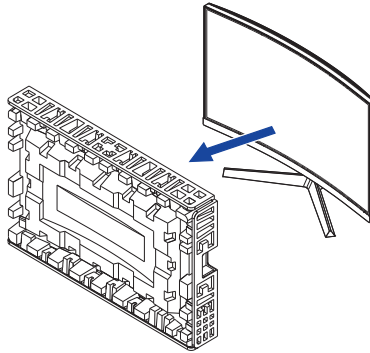

<Removal>

- ① Put the front cushion on a flat surface and place the monitor with face down on it.
- ② Loosen the 'thumb screw' to remove the Stand-Base from the Stand-Neck.
- ③ Press the hook on the back of the monitor and remove the Stand-Neck from the monitor.

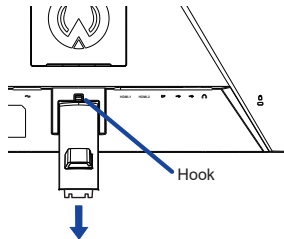

CONTROLS AND CONNECTORS

ENGLISH

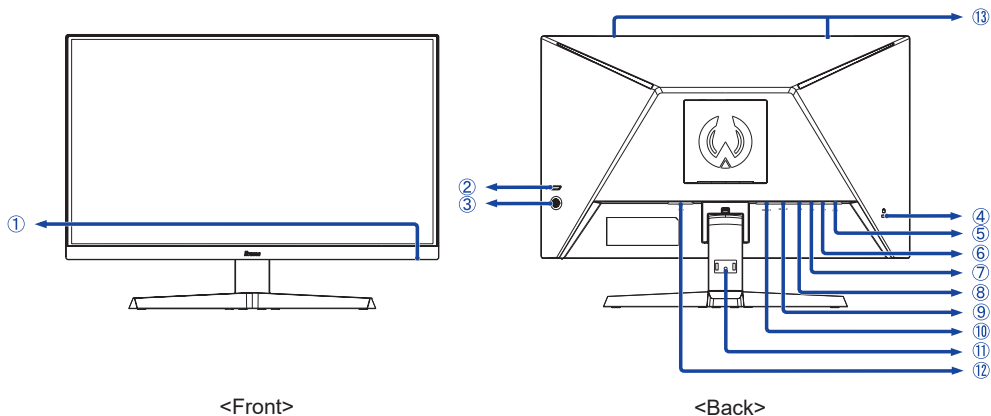

① Power Indicator

NOTE Blue: Normal operation
Orange: Standby mode

② Power Switch (⏻)

③ Navigation Button [MENU]

-Up / Submenu [▲] **Shortcut**

-Down / Input Select [▼] **Direct**

-Left / ECO [◀]* **Direct**

-Right / Volume [▶]* **Direct**

④ Keyhole for Security Lock

NOTE You can fasten a security lock and cable to prevent the monitor from being removed without your permission.

⑤ Headphone Connector (🎧)

NOTE Proper operation of connected external devices other than headphones is not guaranteed.

⑥ USB Downstream Connector (🔌 5V, 500mA)

⑦ USB Upstream Connector (🔌)

⑧ DisplayPort Connector (DP)

⑨ HDMI Connector (HDMI-2)

⑩ HDMI Connector (HDMI-1)

⑪ Installation hole of Cable Holder

⑫ AC Connector (⚡ : Alternating current) (⚡)

⑬ Speakers

* Direction when viewing the screen from the front

CONNECTING YOUR MONITOR

- ① Ensure that both the computer and the monitor are switched off.
- ② Connect the computer to the monitor with the signal cable.
- ③ Connect the computer to the monitor with the USB Cable.
- ④ Connect the Power Cable to the monitor first and then to the power source.
- ⑤ Turn on your monitor and computer.

NOTE

- Make sure that the building installation has a circuit breaker of 120/240V, 20A (maximum).
- The signal cables used for connecting the computer and monitor may vary with the type of computer used. An incorrect connection may cause serious damage to both the monitor and the computer. The cable supplied with the monitor is for a standard connector. If a special cable is required please contact your local iiyama dealer or regional iiyama office.
- The Class I pluggable equipment Type A must be connected to protective earth.
- The socket-outlet shall be installed near the equipment and shall be easily accessible.
- Excessive sound pressure from ear/headphones can cause hearing damage/hearing loss.

[Example of Connection]

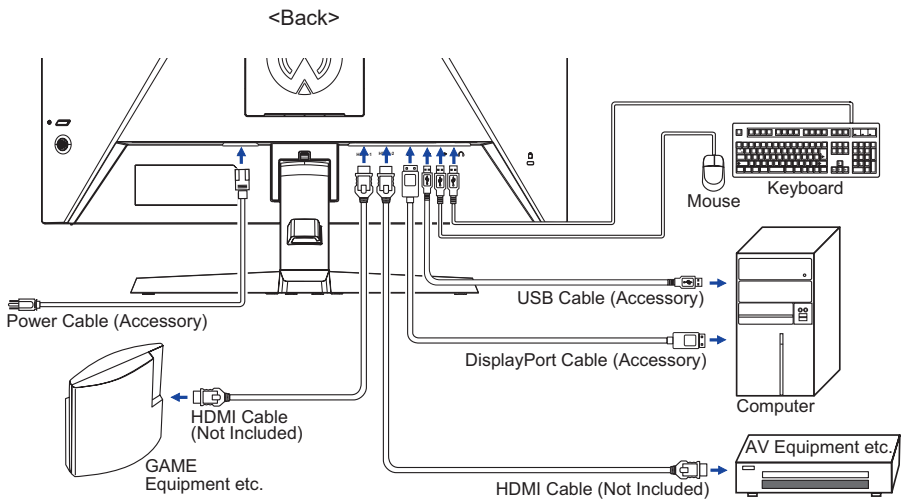

[Collect Cables]

Put the cables through the cable holder to bundle them.

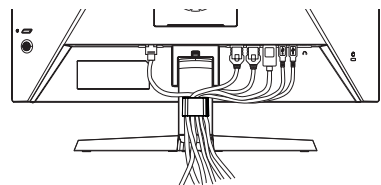

COMPUTER SETTING

■ Signal Timing

Change to the desired signal timing listed on page 29: COMPLIANT TIMING.

ADJUSTING THE VIEWING ANGLE

- For optimal viewing it is recommended to look at the full face of the monitor.
- Hold the stand so that the monitor does not topple when you change the monitor's angle.
- You are able to adjust the monitor's angle up to 22° upward, 4° downward.
- In order to ensure a healthy and relaxed body position when using the monitor at visual display workstations, it is recommended that the adjusted tilt angle should not exceed 10°. Adjust the monitor's angle to your own preference.

NOTE

- Do not touch the LCD screen when you change the angle. It may cause damage or break the LCD screen.
- Careful attention is required not to pinch your fingers or hands into the moving part of the stand when you change the angle.

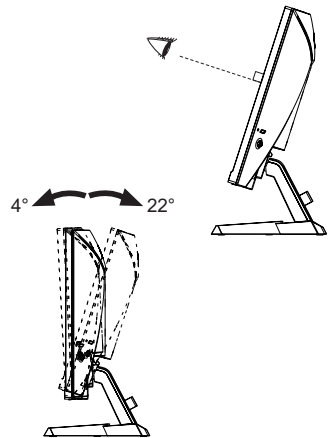

OPERATING THE MONITOR

To create the best picture, your iiyama LCD monitor has been preset at the factory with the COMPLIANT TIMING shown on page 29. You are also able to adjust the picture by following the button operation shown below.

- 1 Press the Navigation Button to start the On Screen Display feature.



- 2 Tilting the Navigation ◀ / ▶ Buttons to select the Menu which contains the item you want to adjust or set and then press the Navigation Button.
- 3 Tilting the Navigation ▲ / ▼ Buttons to highlight the desired adjustment / setting icon and then press the Navigation Button.
- 4 Tilting the Navigation ◀ / ▶ Buttons to make the appropriate adjustment or setting and then press the Navigation Button.
- 5 Tilting the Navigation ◀ Button to leave the menu, and the settings you just made would be automatically saved.

For example, to correct for OSD vertical position, select Menu item of Setup Menu and then press the Navigation Button. Then, select OSD Vertical Position by tilting the Navigation ▲ / ▼ Buttons. An adjustment page appears after you press the Navigation Button.

Then, tilting the Navigation ◀ / ▶ Buttons to change the OSD vertical position settings. The OSD vertical position of the overall display should be changing accordingly while you are doing this.

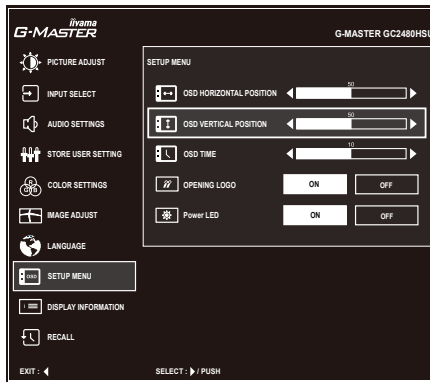

Tilting the Navigation ◀ Button lastly, it ends, all changes are saved in the memory.

NOTE

- When button operations are aborted during adjustment, On-Screen Display disappears when the time set for the OSD Time has passed. Also, tilting the Navigation ◀ button to quickly turn off the On-Screen Display.
- Any changes are automatically saved in the memory when the On Screen Display disappears. Turning off the power should be avoided while using the Menu.
- All adjustments have only one setting which applies to all signal timings.

ADJUSTMENT MENU CONTENTS

Picture Adjust *1

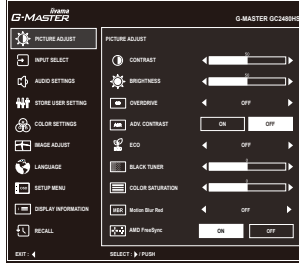

| Adjustment Item | Problem / Option | Button to Press |
|------------------------------------|--|--|
| Contrast | Too dark Too bright | |
| Brightness *2 | Too dull Too intense | |
| Overdrive | Off / 1 / 2 / 3 / 4 / 5 It will improve the gray level response time of the LCD panel. A higher level results in a faster response time. | |
| Adv. Contrast | Off | Typical Contrast Ratio |
| | On | Increased Contrast Ratio |
| ECO Direct | Off | Normal |
| | Mode1 | Brightness of back-light is reduced. |
| | Mode2 | Brightness of back-light is reduced more than Mode1. |
| | Mode3 | Brightness of back-light is reduced more than Mode2. |
| Black Tuner Shortcut | From -5 to +5 You can adjust Dark shades. | |
| Color Saturation | Too weak | |
| | Too strong | |
| Motion Blur Red *3 Shortcut | Off / 1 / 2 / 3 / 4 / 5 / 6 / 7 It will improve the moving picture response time of the LCD panel. A higher level results in a faster response time. | |
| AMD FreeSync Shortcut | Off | The FreeSync function is turned off. |
| | On | Enable the FreeSync function. |

*1 The availability of each item depends on which item is activated. See page 14 “Function Correlation Matrix” for more details.

*2 Adjust the Brightness when you are using the monitor in a dark room and feel the screen is too bright.

*3 Motion Blur Red is available only when the refresh rate is higher than 75Hz.

Direct

You can skip the Menu items and directly display an option setting screen by using the following button operations.

- ECO : Tilt the Navigation ◀ Button when the Menu is not displayed.

Shortcut

You can take a shortcut to the specific menu by the following operations.

- Black Tuner : Tilt the Navigation ▲ Button with no Menu displayed and select “Black Tuner”.
- MBR : Tilt the Navigation ▲ Button with no Menu displayed and select “MBR”.
- AMD FreeSync : Tilt the Navigation ▲ Button with no Menu displayed and select “AMD FreeSync”.
- Night Mode Tilt the Navigation ▲ Button with no Menu displayed and select “Night Mode”.

| Adjustment Item | Option | |
|--|--------|---|
|  Night Mode | Off | Normal |
| | Mode 1 | Brightness is reduced. |
| | Mode 2 | Brightness is reduced more than Mode 1. |
| | Mode 3 | Brightness is reduced more than Mode 2. |

■ Function Correlation Matrix

| Active item Selected item | Picture Adjust | | | | | Image Adjust | Your Computer |
|------------------------------|----------------|-----|--------------------|-----------------|--------------|---|---------------|
| | Adv.Contrast | Eco | Blue Light Reducer | Motion Blur Red | AMD FreeSync | i-Style Color | HDR |
| | | | | | | Standard Sport Game FPS Game Strategy Game Text | |
| Contrast | – | ✓ | ✓ | ✓ | ✓ | – | – |
| Brightness | – | – | ✓ | – | ✓ | – | – |
| Overdrive | ✓ | ✓ | ✓ | – | ✓ | – | ✓ |
| Adv. Contrast | – | – | – | – | ✓ | – | – |
| Eco | – | – | – | – | ✓ | – | – |
| Black Tuner | ✓ | ✓ | ✓ | – | ✓ | – | – |
| Color Saturation | ✓ | ✓ | ✓ | ✓ | ✓ | – | – |
| Motion Blur Red | ✓ | – | – | – | – | ✓ | – |
| AMD FreeSync | ✓ | ✓ | ✓ | – | – | ✓ | – |

- ✓ : Available
- : Not available



Input Select

Direct

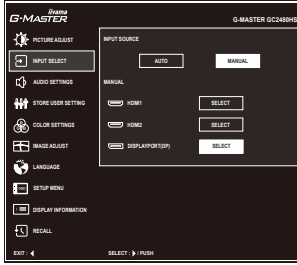

| Adjustment Item | Problem / Option | | Button to Press |
|-----------------|------------------|-----------------|--|
| Input Source | Auto | | Search for an available input source and select automatically. |
| | Manual | HDMI1 | Select the Digital (HDMI1) input. |
| | | HDMI2 | Select the Digital (HDMI2) input. |
| | | DisplayPort(DP) | Select the Digital (DisplayPort) input. |

NOTE Input source is fixed, not selected automatically when HDMI1, HDMI2 and DisplayPort which are selected.

Direct



You can skip the Menu items and directly display an option setting screen by using the following button operations.

- Select Input Source : Tilt the Navigation ▼ Button with no Menu displayed.



Audio Settings



| Adjustment Item | Problem / Option | Button to Press |
|---|----------------------|--|
| Volume Direct | Too soft Too loud |   |
| Mute Audio | Off | Return the sound volume to the previous level. |
| | On | Turn off the sound temporarily. |

NOTE Mute On and Off are switched as follows by tilting the Navigation ► Button successively.
⇒ On → Off

Direct

You can skip the Menu items and directly display an adjustment scale by using the following button operations.

- Volume : Tilt the Navigation ► Button with no Menu displayed.



Store User Setting

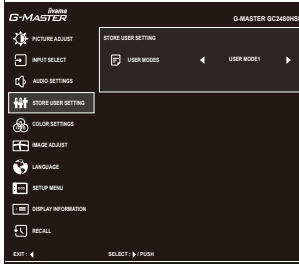

Adjustment Item

Problem / Option

Button to Press

User Modes

| | |
|-------------|---|
| User Mode 1 | Save the settings of the screen adjustment. |
| User Mode 2 | Save the settings of the screen adjustment. |
| User Mode 3 | Save the settings of the screen adjustment. |

NOTE

You can memorize your customized monitor settings.





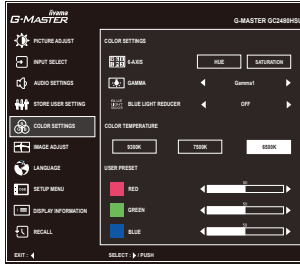

The following settings can be memorized:

Contrast, Brightness, Overdrive, Adv. Contrast, ECO, Volume, Mute Audio, Color Settings, i-Style Color, Sharpness, Black Tuner, Video Mode Adjust



Color Settings



| Adjustment Item | Problem / Option | | Button to Press | |
|--|------------------|--|--|--|
| 6-Axis *1,2 | Hue | Red | Too weak Too strong |   |
| | | Yellow | | |
| | | Green | | |
| | | Cyan | | |
| | | Blue | | |
| | | Magenta | | |
| | Saturation | Red | Too weak Too strong |   |
| | | Yellow | | |
| | | Green | | |
| | | Cyan | | |
| | | Blue | | |
| | | Magenta | | |
| Gamma | Gamma1 | | | |
| | Gamma2 | | | |
| | Gamma3 | | | |
| Blue Light Reducer *1 Direct | Off | Typical | | |
| | Mode1 | Blue light is reduced. | | |
| | Mode2 | Blue light is reduced more than Mode1. | | |
| | Mode3 | Blue light is reduced more than Mode2. | | |
| Color Temperature *2 | 9300K | | Cool color | |
| | 7500K | | Normal color | |
| | 6500K | | Warm color | |
| User Preset *2 | Red | Too weak |   | |
| | Green | Too strong | | |
| | Blue | | | |

*1 6-Axis and Blue Light Reducer are disabled when i-Style Color is activated.

*2 6-Axis, Color Temperature and User Preset are disabled when Blue Light Reducer is activated.

Direct

You can skip the Menu items and directly display an option setting screen by using the following button operations.

- Blue Light Reducer : Tilt and hold the Navigation ▲ Button for 3 seconds with no Menu displayed.

Image Adjust

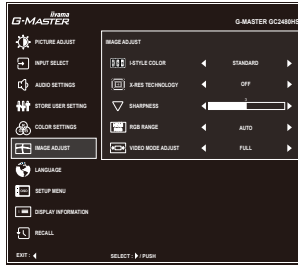

| Adjustment Item | Problem / Option | | Button to Press |
|------------------------------|---|---|-----------------|
| i-Style Color * ¹ | Off | Return to a state set by color adjustment except i-Style Color. | |
| | Standard | For general windows environment and monitor default setting. | |
| | Sport Game | For Sports game environment. | |
| | FPS Game | For FPS game environment. | |
| | Strategy Game | For Strategy game environment. | |
| | Text | For text editing and viewing in a word processing environment. | |
| | User Mode 1 | Applies customized monitor settings. | |
| | User Mode 2 | Applies customized monitor settings. | |
| | User Mode 3 | Applies customized monitor settings. | |
| X-Res Technology | Off | Normal | |
| | Soft | Enhance the picture edge. | |
| | Middle | Enhance the picture edge more than the Soft option. | |
| | Hard | Enhance the picture edge more than the Middle option. | |
| Sharpness | 1 / 2 / 3 / 4 / 5 / 6 You can change the picture quality from 1 to 6 (sharp to soft). Tilt the Navigation ► Button to change the picture quality in numerical order. Tilt the Navigation ◀ Button to change the picture quality in reverse numerical order. | | |
| RGB Range | Auto | Automatically select color scale signal. | |
| | Full | For full-range color scale signal | |
| | Limited | For limited color scale signal | |
| Video Mode Adjust | Full | Expansion display | |
| | Aspect * ² | Expansion display of Aspect | |

*¹ i-Style Color is disabled when Blue Light Reducer is activated.

*² Option unavailable with 16:9 resolution.



Language

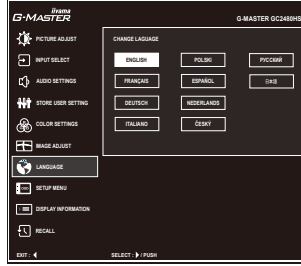

| Adjustment Item | Problem / Option Button to Press | | | |
|-----------------|----------------------------------|---------|------------|----------|
| Language | English | English | Español | Spanish |
| | Français | French | Nederlands | Dutch |
| | Deutsch | German | Česky | Czech |
| | Italiano | Italian | Русский | Russian |
| | Polski | Polish | 日本語 | Japanese |

ENGLISH

Setup Menu

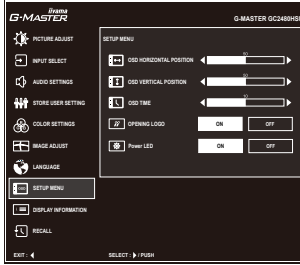

| Adjustment Item | Problem / Option | Button to Press |
|-------------------------|---|---|
| OSD Horizontal Position | OSD is too left | |
| | OSD is too right | |
| OSD Vertical Position | OSD is too low | |
| | OSD is too high | |
| OSD Time | You can set the OSD display duration time between 5 and 30 seconds. | |
| Opening Logo | Off | iiyama Logo does not display when the monitor is turned on. |
| | On | iiyama Logo displayed when the monitor is turned on. |
| Power LED | Off | The Power Indicator is turned Off. |
| | On | The Power Indicator is turned On. |

NOTE Turn Off the Power Indicator when you are bothered by the light.

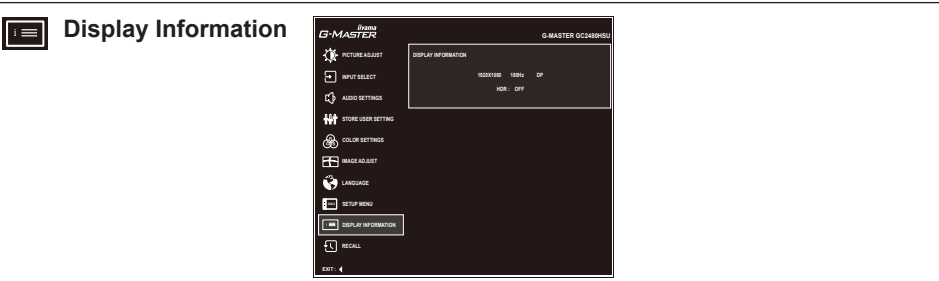

Displays information regarding the current input signal coming from the graphic card in your computer.

"HDR: ON" or "HDR: OFF" will be displayed depending on the settings of your computer.

NOTE See your graphic card user guide for more information about changing the resolution and refresh.

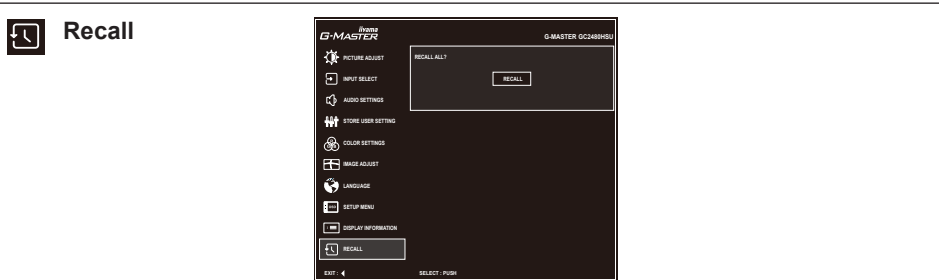

| Adjustment Item | Problem / Option | Button to Press |
|-----------------|----------------------------------|-----------------|
| Recall | Factory-preset data is restored. | |

• Lock Mode

<OSD Menu>

1. The OSD lock will be activated by pressing the Navigation Button for about 10 seconds or more. If you try to access the OSD by pressing any of the Navigation Button, message "OSD Locked" will appear on the screen.
2. The OSD lock will be deactivated by pressing the Navigation Button again for about 10 seconds or more.

<Power Switch>

1. The power switch lock will be activated by tilting the Navigation ◀ Button for about 10 seconds or more. Locking the power switch means that won't be able to turn off the Monitor while the power switch is locked. If presses the power switch message "Power Button Locked" will appear on the screen.
2. The power switch lock will be deactivated by tilting the Navigation ◀ Button again for about 10 seconds or more.

STANDBY FEATURE

This product features the standby function. When activated, it automatically reduces unnecessary power consumption of the monitor when your computer is not in use.

There is a standby step the monitor takes as described below. The standby function, including any timer settings is configured by the operating system. Check your operating system manual for information on how this can be configured.

■ Standby Mode

When the video signal from the computer is off, the monitor enters into Standby Mode which reduces the power consumption to less than 0.5W*. The screen becomes dark, and the power indicator turns to orange. From Standby Mode, the image reappears in several seconds when either the keyboard or the mouse are touched again.

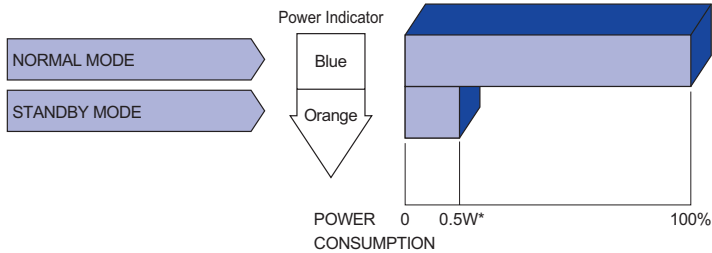

* When the USB devices are not connected.

TROUBLE SHOOTING

If the monitor fails to operate correctly, please follow the steps below for a possible solution.

1. Perform the adjustments described in OPERATING THE MONITOR, depending on the problem you have. If the monitor does not get a picture, skip to 2.
2. Consult the following items if you cannot find an appropriate adjustment item in OPERATING THE MONITOR or if the problem persists.
3. If you are experiencing a problem which is not described below or you cannot correct the problem, discontinue using the monitor and contact your dealer or iiyama service center for further assistance.

Problem

Check

- ① The picture does not appear.

(Power indicator does not light up.)

- The Power Cable is firmly seated in the socket.
- The Power Switch is turned ON.
- The AC socket is live. Please check with another piece of equipment.

(Power indicator is blue.)

- If the blank screen saver is in active mode, touch the keyboard or the mouse.
- Increase the Contrast and/or Brightness.
- The computer is ON.
- The Signal Cable is properly connected.
- The signal timing of the computer is within the specification of the monitor.

(Power indicator is orange.)

- If the monitor is in standby mode, touch the keyboard or the mouse.
- The computer is ON.
- The Signal Cable is properly connected.
- The signal timing of the computer is within the specification of the monitor.

- ② The screen is not synchronized.

- The Signal Cable is properly connected.
- The signal timing of the computer is within the specification of the monitor.

- ③ The screen position is not in the center.

- The signal timing of the computer is within the specification of the monitor.

- ④ The screen is too bright or too dark.

- The video output level of the computer is within the specification of the monitor.

Problem

Check

- | | |
|---------------------------------------|---|
| ⑤ The screen is shaking. | <input type="checkbox"/> The power voltage is within the specification of the monitor. <input type="checkbox"/> The signal timing of the computer is within the specification of the monitor. |
| ⑥ No sound. | <input type="checkbox"/> The audio equipment (computer etc.) is ON. <input type="checkbox"/> The Volume is turned up. <input type="checkbox"/> The Mute is OFF. <input type="checkbox"/> The audio output level of the audio equipment is within the specification of the monitor. |
| ⑦ The sound is too loud or too quiet. | <input type="checkbox"/> The audio output level of the audio equipment is within the specification of the monitor. |

RECYCLING INFORMATION

For better environment protection please don't dispose your monitor.
Please visit our web site: <https://iiyama.com> for monitor recycling.

APPENDIX

Design and specifications are subject to change without prior notice.

SPECIFICATIONS : G-MASTER GC2480HSU-B1

ENGLISH

| | | |
|------------------------------|---|--|
| Size Category | 24" | |
| LCD Panel | Panel technology | VA |
| | Size | Diagonal: 23.6" (60.0cm) |
| | Curvature | 1500 R |
| | Pixel pitch | 0.271mm H × 0.271mm V |
| | Brightness | 300cd/m ² (Typical), 170cd/m ² (Default / Energy Saving) |
| | Contrast ratio | 3000 : 1 (Typical), Adv. Contrast Function Available |
| | Viewable angle | Right / Left : 89° each, Up / Down : 89° each (Typical) |
| | MPRT | 0.5ms |
| Display Colors | Approx. 16.7M | |
| Sync Frequency | HDMI1/2(FreeSync:Off): Horizontal: 30.0-200.0kHz, Vertical: 56-180Hz HDMI1/2(FreeSync:On): Horizontal: 30.0-200.0kHz, Vertical: 48-180Hz DisplayPort(FreeSync:Off):: Horizontal: 30.0-200.0kHz, Vertical: 48-180Hz DisplayPort(FreeSync:On):: Horizontal: 200.0kHz, Vertical: 48-180Hz | |
| Native Resolution | 1920 × 1080, 2.1 MegaPixels | |
| Support max. resolution | HDMI1/2: 1920 × 1080 180Hz DisplayPort: 1920 × 1080 180Hz | |
| Input Connector | HDMI × 2, DisplayPort | |
| Input Video Signal | HDMI, DisplayPort | |
| USB Standard | USB2.0: DC5V, 500mA | |
| Number of USB Ports | 1 Upstream : Series B | |
| Connector shape | 2 Downstream : Series A | |
| Headphone Connector*1 | ø 3.5mm mini jack (Stereo) | |
| Speakers | 2W × 2 (Stereo speakers) | |
| Maximum Screen Size | 521.39mm W × 293.28mm H / 20.5" W × 11.5" H | |
| Power Source | 100-240VAC, 50/60Hz, 1.5A | |
| Power Consumption*2 | 21W typical, Standby mode: 0.5W maximum, Off mode: 0.3W maximum | |
| Dimensions / Net Weight | 535.5 × 394.5 × 202.0mm / 21.1 × 15.5 × 7.9" (W×H×D) 3.8kg / 8.4lbs | |
| Tilt Angle | Upward: 22° Downward: 4° | |
| Environmental Considerations | Operating: Temperature 5 to 35°C / 41 to 95°F Humidity 10 to 90% (No condensation) Storage: Temperature -20 to 60°C / -4 to 140°F Humidity 10 to 90% (No condensation) | |
| Approvals | CE, UKCA, TÜV-Bauart, EAC, VCCI, PSE | |

NOTE

*1 Proper operation of connected external devices other than headphones is not guaranteed.

*2 USB peripherals and audio equipment are not connected.

DIMENSIONS

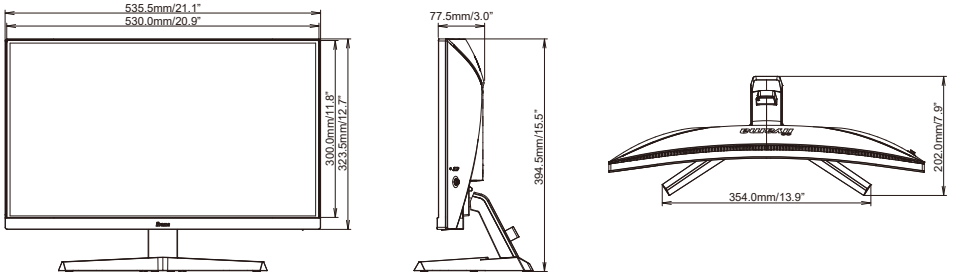

COMPLIANT TIMING

| Video Mode | Horizontal Frequency | Vertical Frequency | Dot Clock |
|-------------|----------------------|--------------------|------------|
| 800 × 600 | 37.879kHz | 60.317Hz | 40.000MHz |
| | 46.875kHz | 75.000Hz | 49.500MHz |
| 1024 × 768 | 48.363kHz | 60.004Hz | 65.000MHz |
| | 60.023kHz | 75.029Hz | 78.750MHz |
| 1280 × 1024 | 79.980kHz | 75.020Hz | 135.000MHz |
| 1600 × 1200 | 75.000kHz | 60.000Hz | 162.000MHz |
| 1680 × 1050 | 65.290kHz | 60.000Hz | 146.250MHz |
| 1920 × 1080 | 67.500kHz | 60.000Hz | 148.500MHz |
| | 137.260kHz | 120.000Hz | 285.500MHz |
| | 166.587kHz | 144.000Hz | 346.500MHz |
| | 183.154kHz | 165.000Hz | 380.960MHz |