

Mounting Instructions

Fixed Universal Screen Bracket

MD 052B1000, MD 052B1010, MD 052B2000

1

Mounting screen profiles

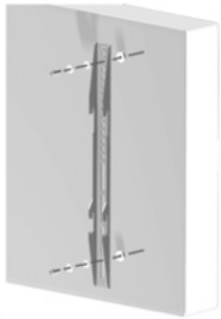

Mount the screen profiles to the back of the screen. Divide the profiles as well as possible.



2x



* use M4, M5, M6 or M8 mounting material (depending on flat screen) (spacers only if necessary)

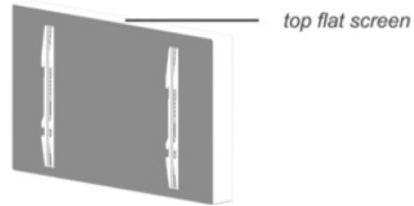

2

Ensure there is a minimum distance of least at least 1.5 m between the wall and one side of the mounting plate, to install the locking bar at step 4. **Mounting back plate**

A

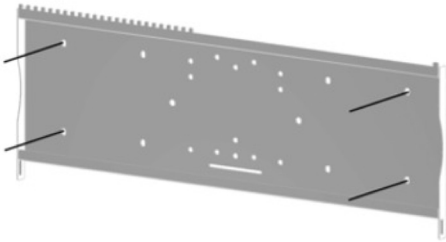

Mounting back plate to the wall

B

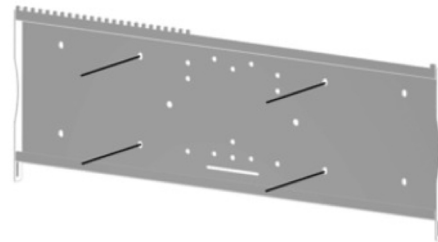

Mounting back plate to the wall (alternative mounting positions)

C

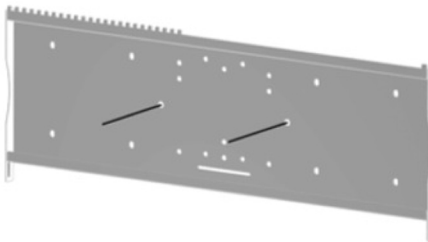

Mounting back plate to truss

D

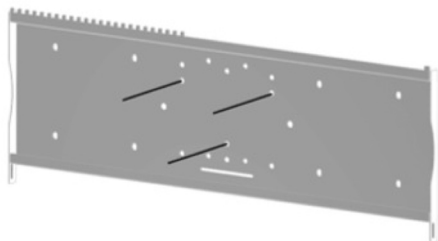

Mounting back plate to flat screen stand

Mounting Instructions

Fixed Universal Screen Bracket

MD 052B1000, MD 052B1010, MD 052B2000

3

Connecting flat screen to base plate

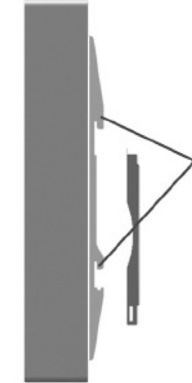
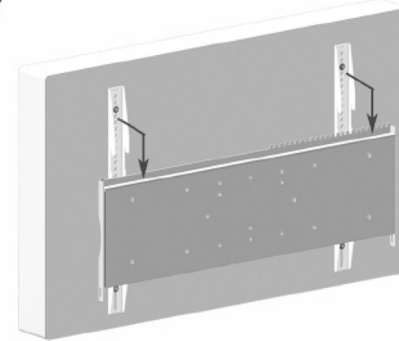

Hook on connecting profiles to the back plate

4

Transit locking bar

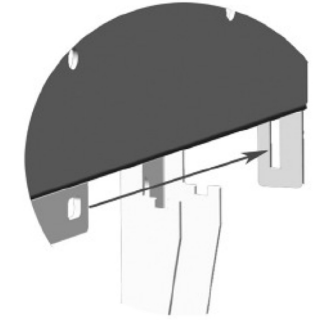
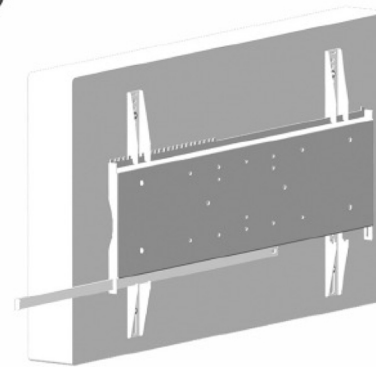

Transit the locking bar through the 'cheeks' of the back plate.

5

Lock (optional)

