

USER MANUAL

ProLite

LCD Monitor

ENGLISH

ProLite LH4342UHS
ProLite LH5042UHS
ProLite LH5542UHS

Thank you very much for choosing the iiyama LCD monitor for signage.
We recommend that you take a few minutes to read this comprehensive manual carefully before installing and switching on the monitor. Please keep this manual in a safe place for your future reference.



Dear user, we congratulate you on the purchase of your iiyama LCD.

For details on warranty and locally used pixel policies that apply directly after installation of your product please check the iiyama website.

To report a fault, please contact your local support centre found at www.iiyama.com/service

Things to check before you call the iiyama information line

- | if the power cable is connected securely and turned on?
- | if the display has been turned on?
- | if the signal cable is connected securely and the correct input selected?
- | if the computer has been restarted with the display connected?
- | if the graphics card is correctly installed with the latest drivers possible?
- | if the correct native resolution has been selected via 'Display Properties'?
- | If the R/G/B signal configuration is correct?
- | if the displays On Screen Menu is shown?
- | if the correct brightness and contrast settings have been set?
- | if given display tolerances and compatibility have been considered?
- | if via the On Screen Menu you have performed a Factory Reset/Recall?

Before reporting the screen defect, please prepare the following information/evidence:

- | model number *
- | purchase receipt and serial number *
- | name and address for collection
- | telephone/fax number, for availability during the day
- | convenient collection date (date, time)
- | short description of the defect

Important Note:

If there is no fault found in the collected equipment after inspection, the transferring party shall incur charges for transport and administration.

If you have checked all of the above and there is still no picture, call our information line for assistance in your country.

* see the identification plate on the back of the case.

CE MARKING DECLARATION OF CONFORMITY

This LCD monitor complies with the requirements of the EC/EU Directive 2014/30/EU "EMC Directive", 2014/35/EU "Low Voltage Directive", 2009/125/EC "ErP Directive" and 2011/65/EU "RoHS Directive".

Warning

This is a class A product. In a domestic environment this product may cause radio interference in which case the user may be required to take adequate measures.

IİYAMA CORPORATION: Wijkemeerstraat 8, 2131 HA Hoofddorp, The Netherlands

Model No. : PL4342UH, PL5042UH, PL5542UH



We recommend recycling of used product. Please contact your dealer or iiyama service center. Recycle information is obtained via the Internet, using the address: <http://www.iiyama.com>

You can access the Web page of different countries from there.

- We reserve the right to change specifications without notice.
- All trademarks used in this user manual are the property of their respective owners.
- Eprel registration number LH4342UHS-B3 : 438129, LH5042UHS-B3 : 442784, LH5542UHS-B3 : 438699

TABLE OF CONTENTS

FOR YOUR SAFETY.....	1
SAFETY PRECAUTIONS.....	1
SPECIAL NOTES ON LCD MONITORS	3
CUSTOMER SERVICE	5
CLEANING	5
BEFORE YOU OPERATE THE MONITOR	6
FEATURES.....	6
CHECKING THE CONTENTS OF THE PACKAGE	6
UNPACKING	7
CONTROLS AND CONNECTORS : MONITOR.....	8
INSTALLATION	10
CONTROLS AND CONNECTORS : REMOTE CONTROL.....	12
PREPARING THE REMOTE CONTROL.....	13
ID REMOTE CONTROL	14
BASIC OPERATION.....	15
CONNECTING YOUR THE MONITOR.....	18
COMPUTER SETTING	21
OPERATING THE MONITOR.....	22
ADJUSTMENT MENU CONTENTS	24
SCREEN ADJUSTMENTS	42
STANDBY FEATURE	45
TROUBLE SHOOTING	46
RECYCLING INFORMATION.....	47
APPENDIX	48
SPECIFICATIONS : ProLite LH4342UHS-B3	48
SPECIFICATIONS : ProLite LH5042UHS-B3	49
SPECIFICATIONS : ProLite LH5542UHS-B3	50
DIMENSIONS : ProLite LH4342UHS	51
DIMENSIONS : ProLite LH5042UHS	51
DIMENSIONS : ProLite LH5542UHS	52
COMPLIANT TIMING	52

FOR YOUR SAFETY

SAFETY PRECAUTIONS

WARNING

STOP OPERATING THE MONITOR WHEN YOU SENSE TROUBLE

If you notice any abnormal phenomena such as smoke, strange sounds or fumes, unplug the monitor and contact your dealer or iiyama service center immediately. Further use may be dangerous and can cause fire or electric shock.

NEVER REMOVE THE CABINET

High voltage circuits are inside the monitor. Removing the cabinet may expose you to the danger of fire or electric shock.

DO NOT PUT ANY OBJECT INTO THE MONITOR

Do not put any solid objects or liquids such as water into the monitor. In case of an accident, unplug your monitor immediately and contact your dealer or iiyama service center. Using the monitor with any object inside may cause fire, electric shock or damage.

INSTALL THE MONITOR ON A FLAT, STABLE SURFACE

The monitor may cause an injury if it falls or is dropped.

DO NOT USE THE MONITOR NEAR WATER

Do not use where water may be splashed or spilt onto the monitor as it may cause fire or electric shock.

OPERATE UNDER THE SPECIFIED POWER SUPPLY

Be sure to operate the monitor only with the specified power supply. Use of an incorrect voltage will cause malfunction and may cause fire or electric shock.

PROTECT THE CABLES

Do not pull or bend the power cable and signal cable. Do not place the monitor or any other heavy objects on the cables. If damaged, the cables may cause fire or electric shock.

ADVERSE WEATHER CONDITIONS

It is advisable not to operate the monitor during a heavy thunder storm as the continual breaks in power may cause malfunction. It is also advised not to touch the plug in these circumstances as it may cause electric shock.

CAUTION

INSTALLATION LOCATION

Do not install the monitor where sudden temperature changes may occur, or in humid, dusty or smoky areas as it may cause fire, electric shock or damage. You should also avoid areas where the sun shines directly on the monitor.

DO NOT PLACE THE MONITOR IN A HAZARDOUS POSITION

The monitor may topple and cause injury if not suitably located. Please also ensure that you do not place any heavy objects on the monitor, and that all cables are routed such that children may not pull the cables and possibly cause injury.

MAINTAIN GOOD VENTILATION

Ventilation slots are provided to keep the monitor from overheating. Covering the slots may cause fire. To allow adequate air circulation, place the monitor at least 10 cm (or 4 inches) from any walls. Operating the monitor on its back, side, upside down or on a carpet or any other soft material may also cause damage.

DISCONNECT THE CABLES WHEN YOU MOVE THE MONITOR

When you move the monitor, turn off the power switch, unplug the monitor and be sure the signal cable is disconnected. If you do not disconnect them, it may cause fire or electric shock.

UNPLUG THE MONITOR

If the monitor is not in use for a long period of time it is recommended that it is left unplugged to avoid accidents.

HOLD THE PLUG WHEN DISCONNECTING

To disconnect the power cable or signal cable, always pull it by the plug. Never pull on the cable itself as this may cause fire or electric shock.

DO NOT TOUCH THE PLUG WITH WET HANDS

Pulling or inserting the plug with wet hands may cause electric shock.

WHEN YOU INSTALL THE MONITOR ON YOUR COMPUTER

Be sure the computer is strong enough to hold the weight of the monitor, otherwise, you may damage your computer.

REMARK FOR 24/7 USAGE

This product is not specifically designed for 24/7 usage.

OTHERS

ERGONOMIC RECOMMENDATIONS

To eliminate eye fatigue, do not operate the monitor against a bright background or in a dark room. For optimal viewing comfort, the monitor should be just below eye level and 40-60 cm (16-24 inches) away from your eyes. When using the monitor over a prolonged time, a ten minute break every hour is recommended as looking at the screen continuously can cause eye strain.

SPECIAL NOTES ON LCD MONITORS

- The following symptoms are normal with LCD monitors and do not indicate a problem.

NOTE

- When you first turn on the LCD monitor, the picture may not fit in the display area because of the type of computer that is used. In this case, adjust the picture position to the correct position.
 - You may find slightly uneven brightness on the screen depending on the desktop pattern you use.
 - Due to the nature of the LCD screen, an afterimage of the previous screen may remain after switching the image, when the same image is displayed for hours. In this case, the screen is recovered slowly by changing the image or turning off the Power Switch for hours.
- This LCD cannot be used outdoors.
 - This LCD cannot be used with the screen facing upwards.
 - If you use a cable longer than the supplied one, the picture quality is not guaranteed.

USAGE CONFIRMATION

This product is designed for optimum usage at 18hours per day.
The monitor is compatible for usage in Landscape/Portrait applications.

IMAGE PERSISTENCE / IMAGE STICKING

Please be aware that all LCD screens can experience Image Persistence or Image Sticking. This occurs when a residual image remains visible on a screen when static images are displayed for long periods of time. LCD Image Persistence is not permanent but constant images being displayed for a long period of time should be avoided.

To counteract Image Persistence, turn off the monitor for as long as the previous image was displayed, so if an image was on the monitor for 1 hour and there is evidence of a residual or “ghost” image, you should turn off the monitor for 1 hour in order to clear the residual image.

For all LFD products, iiyama recommends displaying moving images and utilising a moving screen saver at regular intervals whenever the screen is idle. You could also turn off the monitor when not in use to assist the prevention.

Other ways to reduce the risk of Image Persistence will be to utilise the FAN-on function (if available), Low Backlight and Low Brightness settings.

FOR EXTENDED USE AS A PUBLIC MONITOR

■ Image Sticking on LCD Panel

When a static image is displayed for hours, an electric charge trace remains near the electrode inside the LCD producing a “ghost” image. (Image Persistence).

Image Persistence is not a permanent feature.

■ Recommendations

To prevent Image Sticking and promote longer life expectancy of monitor, we recommend the following:

1. Avoid static images displayed for long periods – change static images on continuous loop.
2. Turn off monitor when not in use, either by remote control or use Standby or Schedule functions.
3. Check the Monitor Menu Settings for "Pixel Shift" etc. and activate it when available. This will reduce the Image Sticking Effect.
4. When monitor is installed in high ambient temperature environment(s) or in an enclosed position, utilise the Cooling Fan, Screen Saver and Low Brightness functions.
5. Suitable ventilation for any monitor is an expectation of any installation – climate control systems may need to be employed.
6. We strongly recommend utilisation of active cooling with fans for long operation times or high ambient temperature environments.

CUSTOMER SERVICE

NOTE

- If you have to return your unit for service and the original packaging has been discarded, please contact your dealer or iiyama service center for advice or replacement packaging.

CLEANING

WARNING

- If you drop any materials or liquids such as water into the monitor when cleaning, unplug the power cable immediately and contact your dealer or iiyama service center.

CAUTION

- For safety reasons, turn off the power switch and unplug the monitor before you clean it.

NOTE

- To protect the LCD panel, do not scratch or rub the screen with a hard object.
- Never use any of the following strong solvents. These will damage the cabinet and the LCD screen.

Thinner	Benzine	Abrasive cleaner
Spray-type cleaner	Wax	Acid or Alkaline solvent

- Touching the cabinet with any product made from rubber or plastic for a long time may cause degeneration or loss of paint on the cabinet.

CABINET

Stains can be removed with a cloth lightly moistened with a mild detergent solvent. Then wipe the cabinet with a soft dry cloth.

LCD

Periodic cleaning with a soft dry cloth is recommended.

SCREEN

Don't use tissue paper etc. because these will damage the LCD screen.

BEFORE YOU OPERATE THE MONITOR

FEATURES

- ◆ Supports Resolutions up to 3840 × 2160
- ◆ High Contrast 1300:1 (Typical) / Brightness 500cd/m² (Typical) : ProLite LH4342UHS / ProLite LH5542UHS
- ◆ High Contrast 4000:1 (Typical) / Brightness 500cd/m² (Typical) : ProLite LH5042UHS
- ◆ Digital Character Smoothing
- ◆ Automatic Set-up
- ◆ Stereo Speakers
2 × 10W Stereo Speakers
- ◆ Standby Feature (VESA DPMS Compliant)
- ◆ VESA Mounting Standard (200mm×200mm) Compliant : ProLite LH4342UHS
- ◆ VESA Mounting Standard (400mm×400mm) Compliant : ProLite LH5042UHS / ProLite LH5542UHS

CHECKING THE CONTENTS OF THE PACKAGE

The following accessories are included in your package. Check to see if they are enclosed with the monitor. If anything is missing or damaged, please contact your local iiyama dealer or regional iiyama office.

- | | | |
|----------------------------|---------------------------|-------------------|
| ■ Power Cable* | ■ HDMI Cable | ■ RS-232C Cable |
| ■ Remote Control | ■ Battery (2pcs) | |
| ■ Stickers for screw holes | 1 sheet (Stickers: 10pcs) | ■ EU Energy Label |
| ■ Safety Guide | ■ Quick Start Guide | |

CAUTION

- * The rating of the Power Cable enclosed in 120V area is 10A/125V. If you are using a power supply higher than this rating, then a power cable with a rating of 10A/250V must be used. However, all guarantees and warranties are void for any problems or damage caused by a power cable not supplied by iiyama. An approved power cable greater or equal to H05VVf, 3G, 0.75mm² must be used.

UNPACKING

CAUTION

Moving the monitor requires at least two people. If not, it may drop and could result in a serious injury.

CONTROLS AND CONNECTORS : MONITOR

<Back Controller>

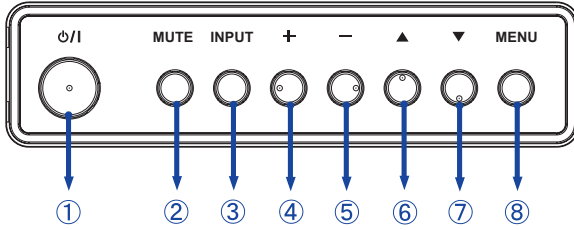

①	⏻/I	Power Button
②	MUTE	Mute Button
③	INPUT	Input Select Button
④	+	+ Button
⑤	-	- Button
⑥	▲	Up Button
⑦	▼	Down Button
⑧	MENU	Menu Button

<Front>

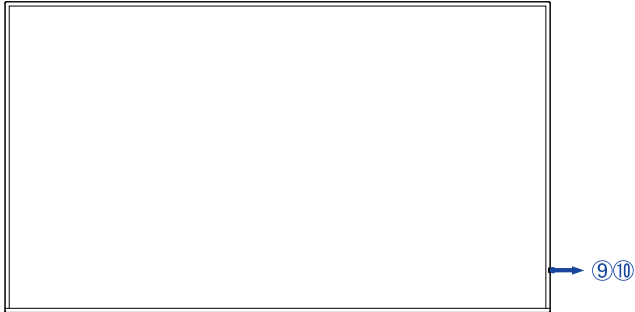

⑨	Power Indicator	Green	Lighting : Normal Operation Flash : When SCHEDULE is enabled.
		Red	If turn off the Power Button on the Remote Control and the Back Controller. Standby Mode
		Off	Power Off
⑩	Remote Sensor		Remote Sensor

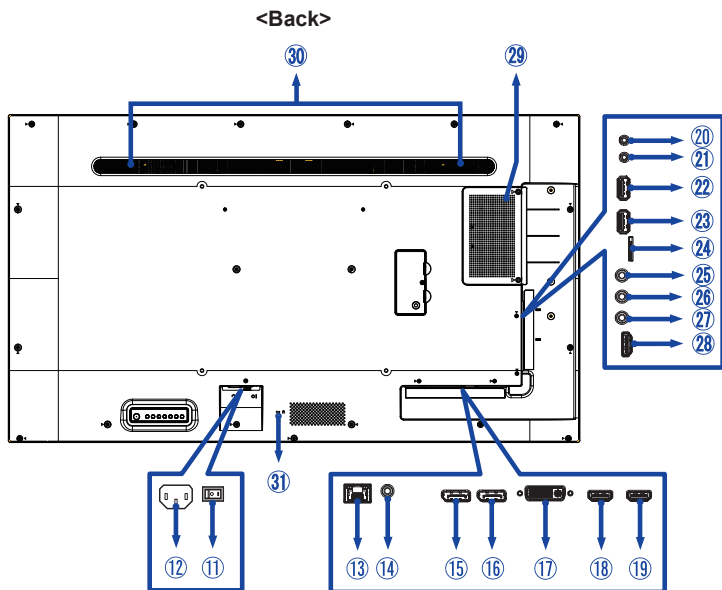

⑪	AC SWITCH I (ON) / O (OFF)	MAIN POWER	Main Power Switch
⑫	AC IN	AC-INLET	AC Connector(~ : Alternating current) (AC-IN)
⑬	LAN	RJ45	RJ45 Connector
⑭	AUDIO OUT	Mini Jack	Headphone Connector
⑮	DisplayPort IN	DisplayPort	DisplayPort Connector
⑯	DisplayPort OUT	DisplayPort	DisplayPort Connector
⑰	DVI IN	DVI-I	DVI-I Connector
⑱	HDMI1 IN	HDMI	HDMI Connector
⑲	HDMI2 IN	HDMI	HDMI Connector
⑳	RS232C OUT	Mini Jack	RS232C Connector
㉑	RS232C IN	Mini Jack	RS232C Connector
㉒	USB2	USB2.0 (5V, 500mA)	USB Connector
㉓	USB1	USB2.0 (5V, 500mA)	USB Connector
㉔	MICRO SD		Micro SD slot
㉕	IR OUT	IR	IR Connector
㉖	IR IN	IR	IR Connector
㉗	AUDIO IN	Mini Jack	Audio Connector
㉘	HDMI3 IN	HDMI	HDMI Connector
㉙	Option Slot (SDM-S: ProLite LH4342UHS, SDM-L: ProLite LH5042UHS / ProLite LH5542UHS)		
⑳	Speakers		
㉑	Keyhole for Security Lock		

INSTALLATION

CAUTION

- Follow the manual instructions for the type of mount you have selected. Refer all servicing to qualified service personnel.
- Moving the monitor requires at least two people.
- Before installing, please make sure the wall is strong enough to hold the necessary weight of the monitor and the mount.

[WALL MOUNTING]

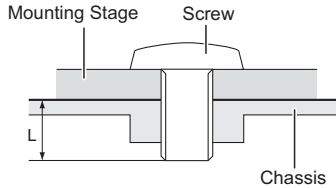

CAUTION

When using the wall mounting, consideration of thickness of the mounting stage needs to be taken. Tighten the M6 Screws (4pcs) with washer which "L" length is 15mm to fasten the monitor. Using a screw longer than this may cause electric shock or damage because it may contact with the electrical parts inside the monitor.

[ROTATING THE MONITOR]

This monitor is designed to be compatible in both landscape and portrait modes.

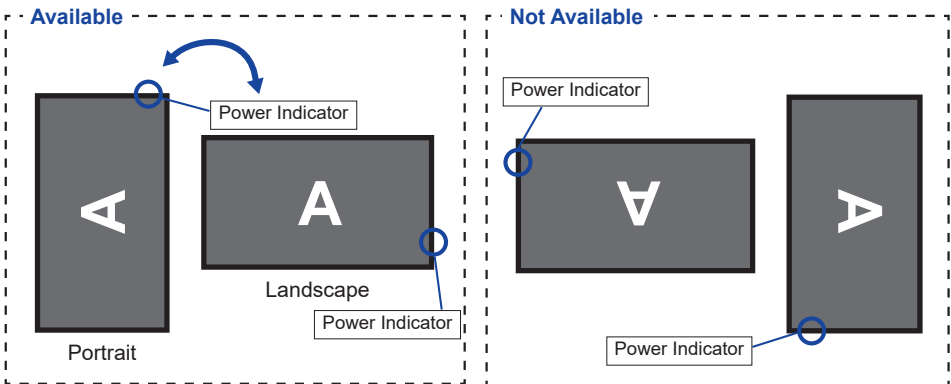

[PLACING THE STICKERS]

If you feel the screw holes are too visible in portrait mode, please use the stickers to cover them.

■ ProLite LH4342UHS

Screw holes : 7



■ ProLite LH5042UHS

Screw holes : 7



■ ProLite LH5542UHS

Screw holes : 7



CONTROLS AND CONNECTORS : REMOTE CONTROL

ENGLISH

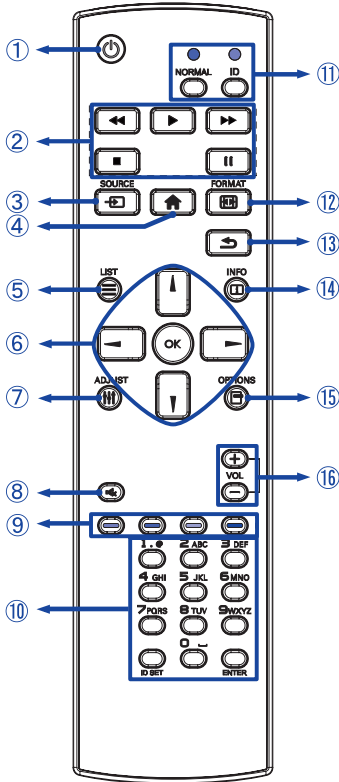

①		Turns the monitor ON and OFF.
②	[PLAY]	Control playback of media files. ▶ : Play ■ : Stop ⏸ : Pause ⏮ : Quick-Return ⏭ : Fast-Forward
③	SOURCE	Selects the source. Press ▲ or ▼ button to select from HDMI1, HDMI2, HDMI3, DVI-I, DisplayPort, VGA, SDM, Media Player, Browser, iiSignage, PDF Player or Custom. Press [OK] button to confirm and exit.
④	HOME	Opens the display's on-screen menu systems.
⑤	LIST	Not available on this model.
⑥		Navigates through submenus and settings. ▲ : Up Button ▼ : Down Button ◀ : Left Button ▶ : Right Button
	OK	Confirms your selection or save changes.
⑦	ADJUST	Auto Adjust function only available when VGA input is selected.
⑧	MUTE	Turns on or off the mute function when the Menu is not displayed.
⑨	COLOR	Select tasks or options. Blue: Zoom in (PDF Player) Yellow: Zoom out (PDF Player)
⑩	NUMBER/ ID SET/ENTER	Enter text for network setting.
⑪	ID Mode	ID: To enter ID Mode NORMAL: To leave ID Mode
⑫	FORMAT	Change picture format.
⑬	BACK	Returns to a previous menu or closes the OSD Menu.
⑭	INFO	Provides source and resolution information.
⑮	OPTIONS	Not available on this model.
⑯	VOLUME - / +	VOLUME-: Decreases the sound volume. VOLUME+: Increases the sound volume.

PREPARING THE REMOTE CONTROL

To use the remote control, insert the two dry batteries.

CAUTION

- Do not use any other batteries other than those specified in this manual for the Remote Control.
- Do not insert old and new batteries together in the Remote Control.
- Make sure that the terminals match the "+" and "-" indications in the battery compartment.
- Remove the dead batteries immediately to prevent them from liquid leaking into the battery compartment.
- Burst batteries or the electrolyte from these batteries may cause stains, fire or injury.

- ① Press and then slide the battery cover to open it.

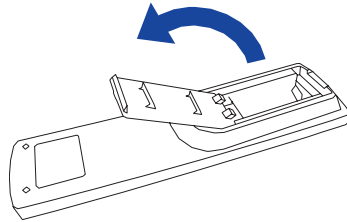

- ② Align and insert two AAA batteries according to their plus and minus ports (as indicated in the remote control).

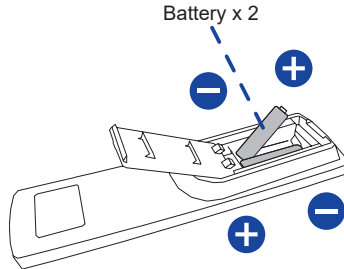

- ③ Replace the battery cover.

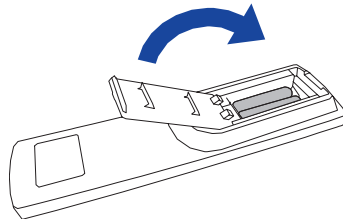

NOTE

- Refer to the above instructions when taking out the batteries.
- Replace with new batteries when the Remote Control does not work close to the monitor.
Use AAA dry batteries. Risk of explosion if battery is replaced by an incorrect type.
- Operate the Remote Control by pointing it toward the Remote Sensor on the monitor.
- Other manufacturers remote control will not work with this monitor. Use the provided Remote Control ONLY.
- Used batteries needed to follow the city rule to be discarded. (suggestion: to dispose of used batteries please follow correct policy as per your council regulations)
- Batteries shall not be exposed to excessive heat such as sunshine, fire or the like.
- If you do not intend to use the remote control for a long period, remove the batteries.

ID REMOTE CONTROL

You can set the remote control ID when you want to use the remote control on specific monitors.

ID Mode (To enter ID Mode) : Press and hold the ID button until the red LED blinks twice.

Normal Mode (To leave ID Mode) : Press and hold the Normal button until the green LED blinks twice.

■ Programming ID Mode

To assign an ID to a remote control.

1. Enter ID Mode.
2. Press and hold the ID SET button until the red LED turned on.
3. Using the number button, input the desired ID. (01 - 255)
4. Press the ENTER button to confirm ID.
5. The red LED will blink twice when ID has been confirmed.
6. Press the ID SET button will exit the ID Mode. The green LED turned on.

NOTE

- Not pressing any button within 10 seconds will exit the ID Mode.
- If an error pressing of buttons other than the digits occurred, wait 1 second after the red LED lights off and then lights up again, then press the correct digits again.
- To cancel or stop programming an ID, press the ID SET button.
- It is necessary to set up the ID number for each monitor before selecting its ID number.

■ Use ID Mode

1. Enter ID Mode.
2. Input the ID of the monitor which would like to control by number button.
3. Press the ENTER button.

BASIC OPERATION

■ Turning the monitor ON

The monitor is turned On and the Power Indicator turns to Green when you press the POWER button on the monitor or the Remote Control. The monitor is turned Off and the Power Indicator turns to Red when you press the POWER button on the monitor or the Remote Control. Press again to turn On the monitor.

NOTE

Even when using the standby mode or turning OFF the Power Switch, the monitor will consume a small amount of electricity. Disconnect the Power Cable from the power supply whenever the monitor is not in use or during the night, to avoid unnecessary power consumption.

[Monitor]

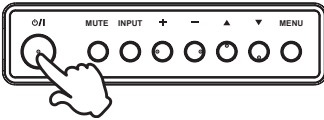

[Remote Control]

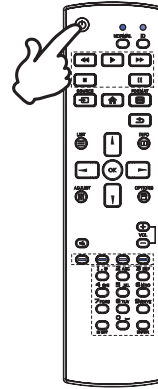

■ Display the adjustment menu page

The menu page appears on the screen when you press the MENU button on the monitor or the  HOME button on the Remote Control.

The menu page disappears when you press the  BACK button on the Remote Control again.

[Monitor]

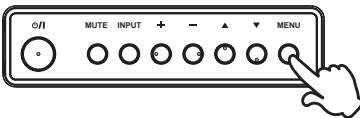

[Remote Control]

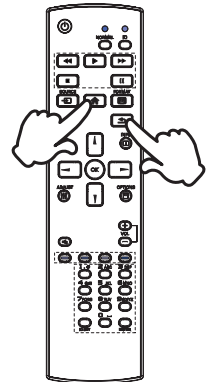

■ Move the cursor vertically

Select adjustment by pressing the ▲ / ▼ button on the monitor or the ▲ / ▼ button on the remote control while the menu page is displayed on the screen.

[Monitor]

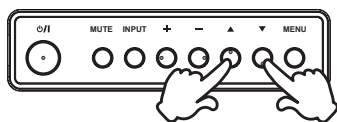

[Remote Control]

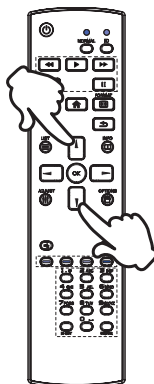

■ Move the cursor horizontally

Select menu or setting, or perform the adjustment by pressing the + / - button on the monitor or the ◀ / ▶ button on the remote control while the menu page is displayed on the screen.

[Monitor]

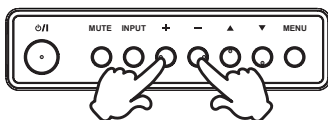

[Remote Control]

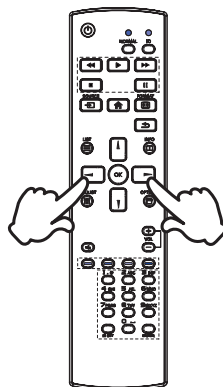

■ Adjust the volume of sound

Press the + / - button on the monitor or the remote control to adjust the volume of sound when the menu page is not displayed on the screen.

[Monitor]

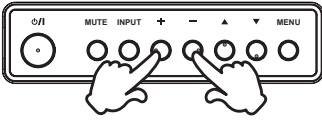

[Remote Control]

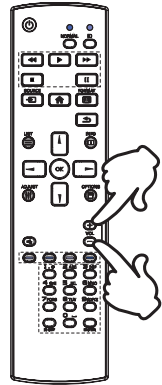

■ Switch the input signal

This is activated when you successively press the INPUT button on the monitor or the SOURCE button on the remote control.

[Monitor]

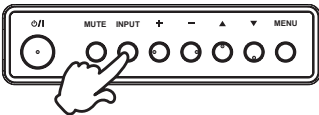

[Remote Control]

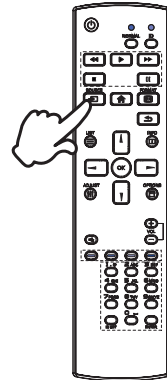

CONNECTING YOUR THE MONITOR

- ① Ensure that both the computer and the monitor are switched off.
- ② Connect the computer to the monitor with the signal cable.
- ③ Connect the computer with the RS-232C Cable from the monitor.
- ④ Connect the Power Cable to the monitor first and then to the power source.
- ⑤ Turn on your monitor (Main Power Switch and Power Switch) and computer.

NOTE

- Make sure that the building installation has a circuit breaker of 120/240V, 20A (maximum).
- The signal cables used for connecting the computer and monitor may vary with the type of computer used. An incorrect connection may cause serious damage to both the monitor and the computer. The cable supplied with the monitor is for a standard connector. If a special cable is required please contact your local iiyama dealer or regional iiyama office.
- Make sure you tighten the finger screws at each end of the Signal Cable.
- The Class I pluggable equipment Type A must be connected to protective earth.
- The socket-outlet shall be installed near the equipment and shall be easily accessible.
- Excessive sound pressure from ear-/headphones can cause hearing damage/hearing loss.

[Example of Connection]

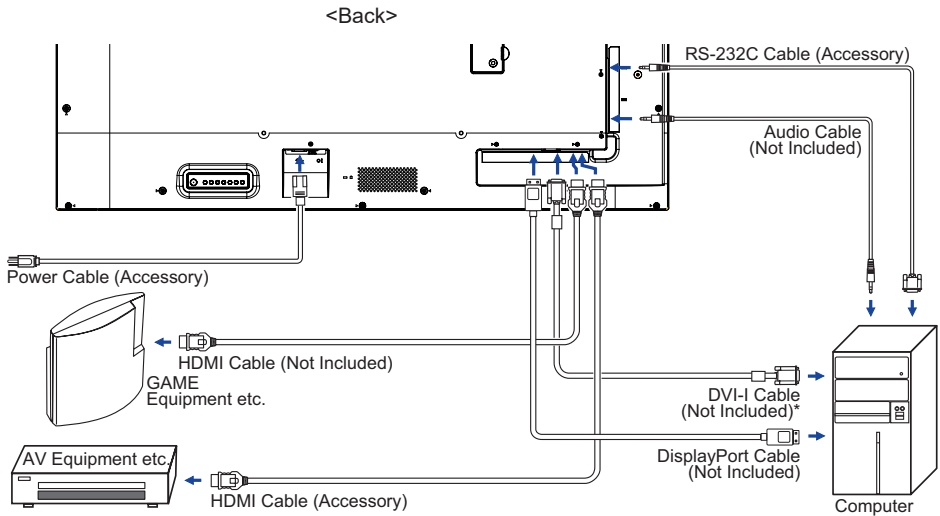

* DVI-I cable is not supplied with the monitor. If you use low quality DVI-I cable, it may cause a result of electro-magnetic interference. Please contact the iiyama Support Centre in your country if you wish to connect the monitor via the DVI input.

[Connection example with the peripheral device]

CAUTION

Turn off the power switch and unplug the monitor and peripherals before connection to avoid electric shock or damage.

NOTE

- Refer to the user manual of peripherals at the same time.
- Ensure you have the necessary cables as required.

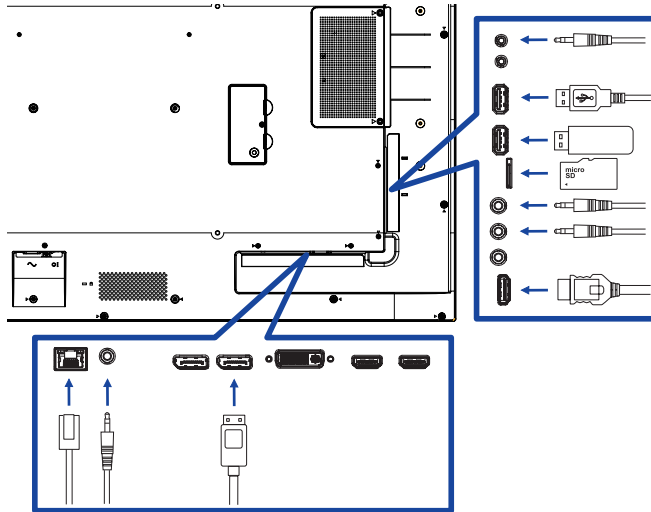

[About the daisy chain]

■ Monitor control connection

RS-232C

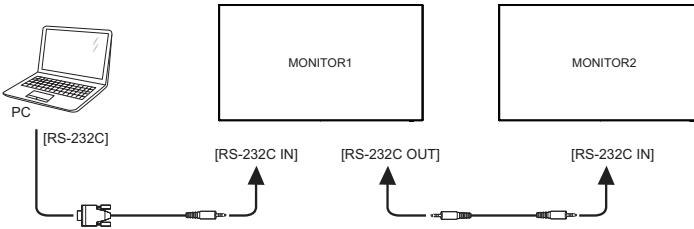

■ Digital video connection

DisplayPort

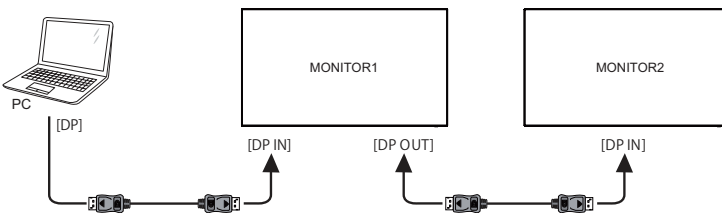

[To setup the network]

1. Switch on the router and switch on its DHCP setting.
2. Connect the router to this monitor with an Ethernet cable.
3. Press  HOME button on the remote control, then select Setup.
4. Select "Connect to network", then press OK button.
5. Follow the on-screen instructions to install the network.
6. Wait for this monitor to find the network connection.
7. If you are prompted, agree to the "End User Licence Agreement".

NOTE Connecting with a shielded CAT-5 Ethernet cable to comply with the EMC directive.

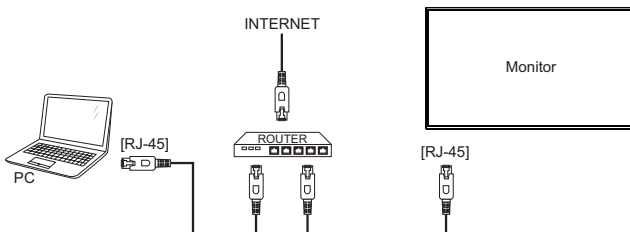

COMPUTER SETTING

■ Signal Timing

Change to the desired signal timing listed on page 52: COMPLIANT TIMING.

■ Windows XP/Vista/7/8/8.1/10 Plug & Play

The iiyama LCD monitor complies with DDC2B of VESA standard. The Plug & Play function runs on Windows XP/Vista/7/8/8.1/10 by connecting the monitor to DDC2B compliant computer with the Signal Cable supplied.

For installation on Windows XP: The monitor Information File for iiyama monitors may be necessary for your computer and obtained via the Internet, using the address:

<http://www.iiyama.com>

NOTE

■ Monitor Drivers are not required in most cases for Macintosh or Unix operating systems. For further information, please contact your computer dealer first for advice.

■ Procedure for turning ON the Power Switch

Turn ON the monitor first, and then the computer.

OPERATING THE MONITOR

To create the best picture, your iiyama LCD monitor has been preset at the factory with the COMPLIANT TIMING shown on page 52. You are also able to adjust the picture by following the button operation shown below. For more detailed adjustments, see page 42 for SCREEN ADJUSTMENTS.

- 1 Press the **HOME** button on the remote control or the **MENU** button on the monitor to start the On Screen Display feature. There are additional Menu items which can be switched by using the **▲/▼** buttons on the remote control or the **▲/▼** buttons on the monitor.

Picture	Brightness	90
Screen	Contrast	50
Audio	Sharpness	20
Configuration1	Black level	50
Configuration2	Tint	50
Advanced option	Color	55
	Noise reduction	Medium
	Gamma selection	Native
	Color temperature	Native
	Color control	Action
	Smart power	Off
	Custom	Off

- 2 Select the Menu item of the adjustment you want to make. Press the **OK** button on the remote control or the **+** button on the monitor and enter the menu page. Then, use the **▲/▼** buttons on the remote control or the **▲/▼** buttons on the monitor to highlight the desired adjustment item.
- 3 Press the **OK** button on the remote control or the **+** button on the monitor again. Use the **◀/▶** buttons on the remote control or the **+/-** buttons on the monitor to make the appropriate adjustment or setting.
- 4 Press the **BACK** button on the remote control or the **MENU** button on the monitor to leave the menu, and the settings you just made would be automatically saved.

For example, to correct for vertical position, select Menu item of "Screen". Press the **OK** button on the remote control or the **+** button on the monitor. Then, select "V. Position" by using the **▲/▼** buttons on the remote control or the **▲/▼** buttons on the monitor.

Picture	H position	
Screen	V position	
Audio	Clock	
Configuration1	Clock Phase	
Configuration2	Zoom mode	Full
Advanced option	Custom zoom	Action
	Auto adjust	Action
	Screen reset	Action

Use the **◀/▶** buttons on the remote control or the **+/-** buttons on the monitor to change the vertical position settings. The vertical position of the overall monitor should be changing accordingly while you are doing this.



Press the **BACK** button on the remote control or the **MENU** button on the monitor lastly, it ends, all changes are saved in the memory.

NOTE

- The  BACK button on the remote control or the + button on the monitor can be used to return previous menu item.
- Any changes are automatically saved in the memory when the On Screen Display disappears. Turning off the power should be avoided while using the Menu.
- Adjustments for H./V. Position, Clock and Phase are saved for each signal timing. Except for these adjustments, all other adjustments have only one setting which applies to all signal timings.

Direct * Available for Remote Control only.

























You can skip the Menu items and directly display an option setting screen by using the following button operations.

- **Auto Adjust:**
Press the ADJUST Button when the Menu is not displayed.
- **Zoom mode:**
Press the FORMAT Button when the Menu is not displayed.

ADJUSTMENT MENU CONTENTS

Picture

Picture	Brightness	90
Screen	Contrast	50
Audio	Sharpness	20
Configuration1	Black level	50
Configuration2	Tint	50
Advanced option	Color	55
	Noise reduction	Medium
	Gamma selection	Native
	Color temperature	Native
	Color control	Action
	Smart power	Off
	OSD	Off









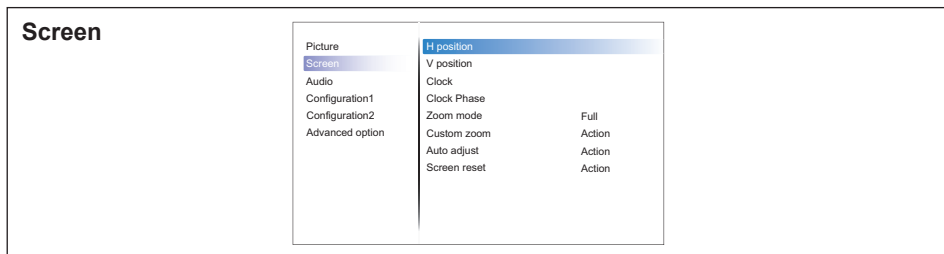





Adjustment Item	Problem / Option		Button to Press	
Brightness* ¹	Too dark Too bright			
				
Contrast* ⁴	Too dull Too intense			
				
Sharpness* ^{2,4}	Too soft Too sharp			
				
Black level* ⁴	Black is too dark Black is too bright			
				
Tint* ⁴	Purplish Greenish			
				
Color* ⁴	Too weak Too strong			
				
Noise reduction* ⁴	Off	Noise Reduction is turned off.		
	Low	Electronic image noise caused by different media players is reduced.		
	Medium	Electronic image noise caused by different media players is reduced more than Low.		
	High	Electronic image noise caused by different media players is reduced more than Medium.		
	Auto	Electronic image noise caused by different media players is reduced by selecting the Auto-setting.		
Gamma selection* ^{3,4}	You can set the Gamma. Native / 2.2 / 2.4 / s gamma / D-image			
Color temperature* ⁴	3000°K	9300°K		
	4000°K	10000°K		
	5000°K	Native	Original color temperature	
	6500°K	User 1	User preset 1	
	7500°K	User 2	User preset 2	

Picture		
Picture	Contrast	50
Screen	Sharpness	20
Audio	Black level	50
Configuration1	Tint	50
Configuration2	Color	55
Advanced option	Noise reduction	Medium
	Gamma selection	Native
	Color temperature	Native
	Color control	Action
	Smart power	Off
	Overscan	Off
	Picture reset	Action

Adjustment Item	Problem / Option		Button to Press
Color control	Set user color.		
	User-R	Too weak Too strong	
	User-G		
	User-B		
Smart power	Off	Normal	
	Midium	Brightness of back-light is reduced. (80%)	
	High	Brightness of back-light is reduced more than Midium. (65%)	
Overscan* ⁴	Off	Over scan is turned off.	
	On	Display area about 95%.	
Picture reset	Cancel	Return to Menu.	
	Reset	Picture setting will be restored to factory-preset data.	

*¹ Adjust the Brightness when you are using the monitor in a dark room and feel the screen is too bright. Brightness adjustment is disabled when Brightness of Panel saving is on.
 *² Not available for VGA(Video) input.
 *³ Press ▼ to display the options.
 *⁴ Not available for Media Player, Browser, iiSignage, PDF Player and Custom inputs.



Adjustment Item	Problem / Option		Button to Press
H Position* ¹	 Too left  Too right		 
V Position* ¹	 Too low  Too high		 
Clock* ^{1,4}	 Too narrow  Too wide		 
Clock Phase* ^{1,4}	To correct flickering text or lines		 
Zoom mode	Full* ^{2,3}	Enlarge the picture horizontally to fill the screen if the picture source is 4:3 (standard definition). When the picture source is 16:9 (high definition), it is not scaled.	
	4:3* ^{2,3}	Display all pictures in 4:3 aspect ratio.	
	Real* ^{2,3}	Display the picture dot by dot.	
	16:9* ^{2,3}	Display all pictures in 16:9 aspect ratio.	
	21:9* ^{2,3}	Display all pictures in 21:9 aspect ratio.	
Custom zoom* ²	Zoom	Zoom the horizontal and vertical size of the image simultaneously.	
	H zoom	Zoom the horizontal size of the image.	
	V zoom	Zoom the vertical size of the image.	
Auto adjust* ^{1,5}	Adjust Position, Clock and Clock Phase automatically.		
Screen reset	Cancel	Return to Menu.	
	Reset	Screen setting will be restored to factory-preset data.	

*¹ Only VGA input.

*² Only VGA and HDMI inputs.















*³ Only Mediaplayer input.

*⁴ See page 42 for SCREEN ADJUSTMENTS.

*⁵ For best results, use the Auto Adjust in conjunction with the adjustment pattern. See page 42 for SCREEN ADJUSTMENTS.

Audio

Picture	Balance	50
Screen	Treble	50
Audio	Bass	50
Configuration1	Volume	20
Configuration2	Audio out (line out)	20
Advanced option	Maximum volume	100
	Minimum volume	0
	Mute	Off
	Audio source	Digital
	Audio reset	Action
	Audio Out Sync	Off
	Speaker Setting	On

Adjustment Item	Problem / Option		Button to Press
Balance	Left side speaker is louder. Right side speaker is louder.		 
Treble	Too weak Too strong		 
Bass	Too weak Too strong		 
Volume	Too soft Too loud		 
Audio out (line out)	Adjust audio output volume. Too soft Too loud		 
Maximum volume	Set the maximum volume.		 
Minimum volume	Set the minimum volume.		 
Mute	Off	Return the sound volume to the previous level.	
	On	Turn off the sound temporarily.	
Audio Source	Analog	Select the VGA input.	
	Digital	Select the HDMI/DisplayPort input.	
Audio reset	Cancel	Return to Menu.	
	Reset	Audio setting will be restored to factory-preset data.	
Audio out sync	Off	Disable audio out (line out) volume.	
	On	Enable audio out (line out) volume.	
Speaker Setting	Off	Disable the built-in speaker.	
	On	Enable the built-in speaker.	

Configuration1

Picture	Switch on state	Force on
Screen	Panel saving	Action
Audio	RS232 routing	RS232
Configuration1	Boot on source	Action
Configuration2	WOL	Action
Advanced option	Configuration1 reset	Action
	Factory reset	Action

Adjustment Item	Problem / Option		Button to Press
Switch on state	Power off	The monitor will remain off when the power cord is connected to a wall outlet.	
	Forced on	The monitor will turn on when the power cord is connected to a wall outlet.	
	Last status	The monitor will return to the previous power status (on/off/standby) when removing and replacing the power cord.	
Panel saving	Brightness	Off	Brightness is turned off.
		On	The image brightness will be reduced to an appropriate level.
	Pixel shift*1	For the monitor to slightly expand the image size and shift the position of pixels in four directions (up, down, left or right).	
		Off	Pixel shift is turned off.
		Auto	Move the position of the image automatically.
10-900	Move the position of the image at set intervals.		
RS232-routing	Select the network control port. RS232 / LAN → RS232		
Boot on source*2,3	Last input	When the power is turned on, it starts with the same setting as when the power was last turned off. Disable / Enable	
	Input	Select input source when boot up. HDMI1 / HDMI2 / HDMI3 / DVI-I / DisplayPort / VGA / SDM*4 / Media Player / Browser / iiSignage / PDF Player / Custom	
	Playlist	Select playlist index for Mediaplayer, Browser and PDF player.	
WOL	Off	Disable wake on LAN function.	
	On	Enable wake on LAN function.	
Configuration1 reset	Cancel	Return to Menu.	
	Reset	Configuration1 setting will be restored to factory-preset data.	
Factory reset	Cancel	Return to Menu.	
	Reset	Factory-preset data is restored.	

*1 Only VGA and HDMI input.

*2 No failover function, system will keep source even the source is no signal input.

*3 Press ▼ to display the options.

*4 It can be used only when SDM-S/SDM-L is installed.

Configuration2																																						
<table border="1"> <tr><td>Picture</td><td>OSD turn off</td><td>115</td></tr> <tr><td>Screen</td><td>OSD H position</td><td>50</td></tr> <tr><td>Audio</td><td>OSD V position</td><td>50</td></tr> <tr><td>Configuration1</td><td>System Rotation</td><td>Action</td></tr> <tr><td>Configuration2</td><td>Information OSD</td><td>10</td></tr> <tr><td>Advanced option</td><td>Logo</td><td>On</td></tr> <tr><td></td><td>Monitor ID</td><td>Action</td></tr> <tr><td></td><td>Heat status</td><td></td></tr> <tr><td></td><td>Monitor information</td><td>Action</td></tr> <tr><td></td><td>DP Version</td><td></td></tr> <tr><td></td><td>HDMI Version</td><td></td></tr> <tr><td></td><td>Configuration2 reset</td><td>Action</td></tr> </table>			Picture	OSD turn off	115	Screen	OSD H position	50	Audio	OSD V position	50	Configuration1	System Rotation	Action	Configuration2	Information OSD	10	Advanced option	Logo	On		Monitor ID	Action		Heat status			Monitor information	Action		DP Version			HDMI Version			Configuration2 reset	Action
Picture	OSD turn off	115																																				
Screen	OSD H position	50																																				
Audio	OSD V position	50																																				
Configuration1	System Rotation	Action																																				
Configuration2	Information OSD	10																																				
Advanced option	Logo	On																																				
	Monitor ID	Action																																				
	Heat status																																					
	Monitor information	Action																																				
	DP Version																																					
	HDMI Version																																					
	Configuration2 reset	Action																																				
Adjustment Item	Problem / Option		Button to Press																																			
OSD turn off	You can set the OSD display duration time between 5 and 120 seconds. Off / 5 - 120 seconds																																					
OSD H position	OSD is too left																																					
	OSD is too right																																					
OSD V position	OSD is too low																																					
	OSD is too high																																					
System Rotation	Landscape	Display the OSD in Landscape mode.																																				
	Portrait	Display the OSD in Portrait mode.																																				
Information OSD	Set the period of time the information OSD is displayed on the upper right corner of the screen. Off / 1 - 60 seconds																																					
Logo	Off	iiyama Logo does not display when the monitor is turned on.																																				
	On	iiyama Logo displayed when the monitor is turned on.																																				
	User*1	Custom logo option in android is set, there will be only custom logo when the monitor is turned on.																																				
Monitor ID	Set ID to the monitor. 1 - 254																																					
Heat status	This function allows you to check the thermal status of the display at any time.																																					
Monitor information	Shows information about your monitor, including Model name, Serial No., Operation hours and SW version.																																					
DP Version*2	Set the version of the DisplayPort. 1.1 / 1.2																																					
HDMI Version*3	Set the version of the HDMI. 1.4 / 2.0																																					
Configuration2 reset	Cancel	Return to Menu.																																				
	Reset	Configuration2 setting will be restored to factory-preset data.																																				

*1 When you would like to use a Custom Boot Logo, go to Settings → Signage Display → General settings and set Boot Logo.

*2 Suitable for DisplayPort input only.

*3 Suitable for HDMI input only.

Advanced option

Picture	IR control	Unlock
Screen	Power LED Light	On
Audio	Keyboard control	Unlock
Configuration1	Tiling	Action
Configuration2	Off timer	Off
Advanced option	Schedule	Action
	HDMI with One Wire	Off
	HDMI with One Wire Power Off	Off
	Auto signal detection	Action
	Language	English
	OSD transparency	Off
	Power Save	Movie1

Adjustment Item	Problem / Option		Button to Press
IR control	Select the operation mode of the remote control when multiple monitors are connected via an RS232C connection.		
	Unlock* ¹	Unlock the remote control.	
	Lock All	Lock all of the remote control.	
	Lock all but Volume	Lock all except the volume of the remote control.	
	Lock all but Power	Lock all except the power of the remote control.	
	Lock all except PWR & VOL	Lock all except the volume and power of the remote control.	
	Primary	Set the monitor as the primary monitor for remote control operation.	
Secondary	Set the monitor as the secondary monitor. This monitor can not be operated by the remote control, and will only receive the control signal from the primary monitor via the RS232C connection.		
Power LED light	Off	The Power Indicator is turned Off.	
	On	The Power Indicator is turned On.	
Keyboard control	Lock the keyboard function. (Control buttons)		
	Unlock* ²	Unlock the keyboard.	
	Lock All	Lock all of the keyboard.	
	Lock all but Volume	Lock all except the volume of the keyboard.	
	Lock all but Power	Lock all except the power of the keyboard.	
Lock all except PWR & VOL	Lock all except the volume and power of the keyboard.		

*¹ To unlock, press and hold the INFO button on the remote control for 6 seconds.

*² To unlock, hold the + button and ▲ button on the monitor for more than 3 seconds, it will lock/unlock the control button function.

Advanced option

Picture	IR control	Unlock
Screen	Power LED Light	On
Audio	Keyboard control	Unlock
Configuration1	Tiling	Action
Configuration2	Off timer	Off
Advanced option	Schedule	Action
	HDMI with One Wire	Off
	HDMI with One Wire Power Off	Off
	Auto signal detection	Action
	Language	English
	OSD transparency	Off
	Power Save	Movie1

Adjustment Item	Problem / Option		Button to Press	
Tiling ^{*3}	H monitors	Sets the number of monitors used in the horizontal position.	← ↑	
	V monitors	Sets the number of monitors used in the vertical position.	← ↓	
	Position	Sets the position of the screen matrix. ^{*4}	← ↑	
	Frame comp.	Off	Frame comp. is turned off.	
		On	The monitor will adjust the image to compensate for the width of the monitor bezels in order to accurately display the image.	
	Enable	Off	Enable is turned off.	
On		The monitor will apply the settings in "H monitors", "V monitors", "Position" and "Frame comp."		
Switch on delay	Adjust the power-on delaying time (in seconds) allows a sequential powering-on for each monitor by their ID number when multiple monitors are connected. Off(0) / Auto(1 - 255) seconds			

^{*3} With this function you can create a single large-screen matrix (video wall) that consists of up to 100 sets of this monitor (up to 10-sets on the vertical and 10-sets on the horizontal sides). However, the image quality may be degraded, display speed may be slowed down, or noise may occur and pictures may not be displayed correctly. It is recommended that the screen matrix be set to a maximum of 5 x 5 screen configurations (25 monitors).

^{*4} Screen Matrix

Example: 2 x 2 screen matrix (4 monitors)

H monitors = 2 monitors

V monitors = 2 monitors

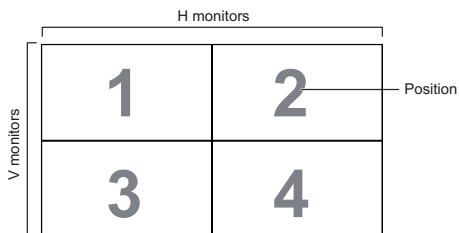

Example: 5 x 5 screen matrix (25 monitors)

H monitors = 5 monitors

V monitors = 5 monitors

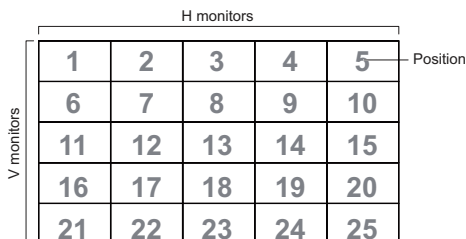

Advanced option

Picture	IR control	Unlock
Screen	Power LED Light	On
Audio	Keyboard control	Unlock
Configuration1	Tiling	Action
Configuration2	Off timer	Off
Advanced option	Schedule	Action
	HDMI with One Wire	Off
	HDMI with One Wire Power Off	Off
	Auto signal detection	Action
	Language	English
	OSD transparency	Off
	Power Save	Menu1

Adjustment Item	Problem / Option		Button to Press
Off Timer	Set when turn off the monitor. Off / 1 - 24 hours		
Schedule	Schedule list		Up to 7 schedules can be set.
	Schedule 1/2/3/4/ 5/6/7	Enable	Enable / disable schedule. NOTE If set with other schedule list conflict, you can not enable schedule.
		Start time	Set start time.
		End time	Set end time.
		Input	Select default input source to use when the monitor is automatically turned on next time. HDMI1 / HDMI2 / HDMI3 / DVI-I / DisplayPort / VGA / SDM ^{*5} / Media Player / Browser / iiSignage / PDF Player / Custom
		Playlist 1/2/3/4/5/6/7	Choose playlist (1 - 7) for the mediaplayer, PDF player and browser.
		Days of the week	Set the day of the week. Sun / Mon / Tue / Wed / Thu / Fri / Sat
		Every week	Set whether to repeat every week.
	Back	Does not change schedule data.	
	Save	Save schedule data.	
HDMI with One Wire	Off	HDMI with One Wire is turned off.	
	On	Control all devices connected by HDMI cable with one remote control.	
HDMI with One Wire Power Off	Off	HDMI with One Wire Power Off is turned off.	
	On	Use the power button on the device connected with the HDMI cable to switch to standby mode.	
Auto signal detection ^{*6}	Off	Disable the Auto signal detection.	
	All ^{*7}	Detects all sources automatically if there is no signal on the default input and selects the available signal automatically.	
	Failover	Detects sources automatically with user-defined order if there is no signal on the default input and selects the available signal automatically.	

^{*5} It can be used only when SDM-S/SDM-L is installed.

^{*6} The display detects and select available signal source automatically.

^{*7} Order of detection: HDMI1 → HDMI2 → HDMI3 → DP → OPS → Media Player → Browser → iiSignage → PDF Player → Custom

Adjustment Item		Problem / Option		Button to Press	
Language	English	English	繁體中文	Traditional Chinese	
	Deutsch	German	日本語	Japanese	
	简体中文	Simplified Chinese	Português	Portuguese	
	Français	French	اللغة العربية	Arabic	
	Italiano	Italian	Dansk	Danish	
	Español	Spanish	Svenska	Swedish	
	Русский	Russian	Suomalainen	Finnish	
	Polski	Polish	Norsk	Norwegian	
	Türkçe	Turkish	Nederlands	Dutch	
OSD Transparency	The background of OSD is made transparent. Off / 1 - 100 				
Power Save		Power button off	No signal	WOL	Android
	Mode1	DC off	DC off	On	ARM off
	Mode2	Not available on this model.			
	Mode3	Backlight off	Backlight off	Off	ARM off
	Mode4	Backlight off	Backlight on, show "no signal"	Off	ARM off
SDM settings* ⁸	Auto	When turning on the display power and switching input source to SDM, SDM power is automatically turned on.			
	Always off	SDM is always turned Off.			
	Always on	SDM is always turned On.			
Advanced option reset	Cancel	Return to Menu.			
	Reset	Advanced option setting will be restored except "Date and Time" in the Advanced option menu to factory-preset data.			

*⁸ When "Power save" is set to Mode 3 or Mode 4, the backlight turns off but SDM keeps on state.

APPLICATION

Press the  HOME button and number 1668 on the remote control.

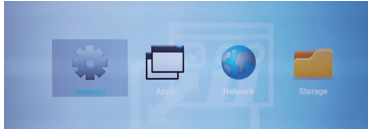

or

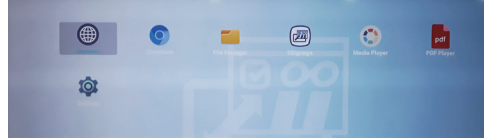

<Settings>

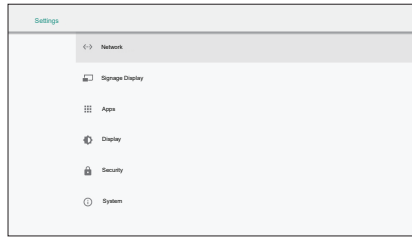

Adjustment Item	Problem / Option		
Network	Ethernet	Set the wired network. Disable / Enable (Connection Type: DHCP/Static IP/IP Address/Netmask/DNS Address/Gateway, MAC Address)	
Signage Display	General settings	Signage Display name	Set the monitor name Ethernet Mac Address.
		Boot Logo* ¹	Select Boot Animation* ²
		Screenshot	Disable / Enable(Interval, Start time, End time, Repeat, Save to, Purge Screenshots, Send screenshots via email)
	Server settings	Email Notification	Disable / Enable(SMTP, Manager Email, Test)
		FTP	Disable / Enable(Account, Password, Storage Path, Port)
	Source settings	Media Player	Edit Media Player playlist and effect settings.
		Browser	Edit Bookmark configuration.
		iiSignage* ³	Set the iiSignage.
		PDF Player	Edit PDF Player playlist and effect settings.
		Custom app	Edit the Custom app.
	Network application	Proxy	Set the proxy server. Disable / Enable (Hostname: Proxy server IP Adress, Port: Proxy server port number, Type: Proxy server type)
		Platform Web API	Disable / Enable(Platform Web API)
		OTSP Network Port	Change the OTSP Network Port.

*¹ The Boot Logo is only available when you select "User" of Logo function in the OSD menu "Configuration2".

*² For details, refer to download the Custom Boot Animation manual on the Iiyama web site.

*³ For details, refer to download the iiSignage manual on the Iiyama web site.

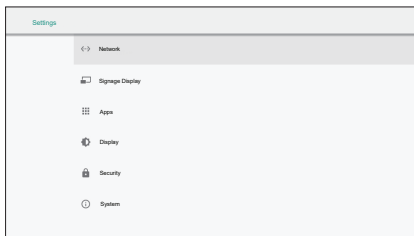

Adjustment Item	Problem / Option			
Signage Display	System Tools	Clear Storage	Clear all data in signage folders. All / Internal storage / USB storage / SD card	
		Factory Reset	Cancel	Return to Menu.
			OK	Factory-preset data is restored.
		Export signage Display settings	Export to signage folder under USB/SD. USB storage / SD card	
		Import signage Display settings	Import from signage folder under USB/SD. USB storage / SD card	
		Clone Media File	Copy the media file from internal, USB or SD folder.	
	External Storage	Disable	SD card / USB External Storage unlock.	
Enable		SD card / USB External Storage lock.		
System updates	Local update	Firmware update.		
Apps	Display applications information.			
Display	Set the font size.			
Security	Display credential storage information.			
System	Date & Time	Display Date & Time information.		
	Developer options	When you change the system settings, a problem like system instability may occur. In that case, contact your dealer or iiyama service center for assistance.		
	About	Main info in About: System updates / Android version / Kernel version / Build number Automatically search update .zip from USB or SD card. When you select the updated .zip file, the monitor will restart and the update will start.		

Save: Save
Forget: Delete

Discard: Discard
Cancel: Close without saving

■ Quick Info

Press the Info button and number 77 on the remote control.
Display the Network and Monitor etc. information.

<Android> * Android upgrade is not available on this model.

- Settings : Go to settings app.
- Apps : Show all apps. (Browser/Chromium/iiSignage/File Manager/Media Player/PDF player/Settings)
- Network : Set Ethernet.
- Storage : Display current Android storage information.

● Preparation for using Media Player and PDF Player

In order to use the Media Player you need to save the file in an specific file folder on your USB or SD card.

1. Create a folder called "signage" on your USB or SD card, create a subfolders (video / photo / music / pdf) in that folder.
 - videos in /signage/video/
 - photos in /signage/photo/
 - music in /signage/music/
 - pdfs in /signage/pdf/
2. Save the Video / Photo / Music / PDF files in the subfolders of your USB or SD card.
3. Insert your USB or SD card into an USB port or SD card slot of the monitor.
4. When using internal storage, save the necessary files of your USB or SD card to an appropriate signage folder and subfolders in the internal storage of the monitor.
 - videos in /signage/video/
 - photos in /signage/photo/
 - music in /signage/music/
 - pdfs in /signage/pdf/

NOTE

Make sure you select the right folder.

If you save the file in the wrong folder, you may not find it.

■ Slide bar

- **Open:** Open folder (USB/SD card)
- **Delete:** Delete files.
- **Copy:** Copy files.
- **Move:** Move files.
- **Select:** Select files.
- **Select All:** Select all files.

■ Supported file system:

FAT32

■ Supported file format:

- Music: MP3, WMA, WMA pro, M4A, AAC, LPCM
- Video: AVI, MP4, 3GPP, MKV, ASF, VRO VOB, PS, TS
- Photo: JPEG, BMP, PNG, GIF

[Media Player]

- Play: Select playlist to play
- Compose: Edit playlist
- Settings: Setting play properties





● Compose

1. Select "Compose" on the page. First you select one playlist to play between FILE1 and FILE7.
2. Select the file and select edit or delete.
3. Save the edited file.
 - videos in /signage/video/
 - photos in /signage/photo/
 - music in /signage/music/
4. When you create photo list you will be asked if you want to play back ground music during slideshow playback. Set as required.

■ Slide bar

- **Source:** Select storage (USB/SD card)
- **Playlist:** Show playlist (Internal)
- **Select all:** Select all storage files.
- **Delete all:** Delete playlist files.
- **Add/Remove:** Update playlist from the source.
- **Sort:** Sort playlist.
- **Save/Abort:** Save or abort playlist.
- **Back:** Return.





■ Remote control

-  **Option key:** Display sidebar
-  **Play key:** Play media file
-  **Pause key:** Pause
-  **Info key:** Show media info
-  **OK key:** Select / deselect file

● Play

Select "Play" on the page. First you select one playlist to play between FILE1 and FILE7.

■ Media Hotkey

-  **Play:** To play the media file.
-  **Pause:** To pause the media file.
-  **Fast forward:** To skip forward 20 seconds.
-  **Rewind:** To skip backward 20 seconds.
-  **Stop:** To stop the media file. If it is a gif file, it will pause.

- **Settings**

Select "Settings" on the page.

- **Repeat mode:** Play mode.

Repeat once: All files are repeated once.

Repeat all: All files in the same folder play repeatedly.

- **Slideshow Effect:** Photo slideshow effect.

Right to left: Change from right to left sliding.

Fold: Change by rotating horizontally in the center.

Corner: Change by enlarging from the upper left corner to the lower right corner.

None: Normal

- **Effect Duration:** Photo effect duration. 5s/10s/15s/20s

[Browser]

- **Settings**

Select "Settings" on the page.

- Set frequently used URL.

1. Select 1 - 7.

2. Enter URL and press OK.

3. Press 'Option' to display the slide bar.

Import: Import URL list file

Export: Export URL list file

Delete all: Delete all URL record

Back: Slide bar will be closed

[PDF Player]





● Compose

1. Select "Compose" on the page. First you select one playlist to play between FILE1 and FILE7.
2. Select the file and select edit or delete.
3. Save the edited file.
-pdfs in /signage/pdf/

■ Slide bar

- **Source:** Select storage (USB/SD card)
- **Playlist:** Show playlist (Internal)
- **Select all:** Select all storage files.
- **Delete all:** Delete playlist files.
- **Add/Remove:** Update playlist from source.
- **Sort:** Sort playlist.
- **Save/Abort:** Save or abort playlist.
- **Back:** Return.





■ Remote control

-  **Option key:** Display sidebar
-  **Play key:** Play media file
-  **Info key:** Show media info
-  **OK key:** Select / deselect file

● Play

Select "Play" on the page. First you select one playlist to play between FILE1 and FILE7.







■ Media Hotkey

-  **Play:** To play the PDF file.
-  **Pause:** To pause the PDF file.
-  **Fast forward:** Go to the next page, if the page is end of the file, it will go to next file.
-  **Rewind:** Back to previous page, if the page is first of the file, it will back to previous file.
-  **Stop:** Return to first page of file.

■ Color Hotkey

- **Blue key:** Zoom in (+10%)
- **Yellow key:** Zoom out (-10%)
-  **OK key:** Restore zoom

■ Arrow key

-  /  /  /  : Adjust page (When the page has zoomed in/out)
-  : Previous page (When the page has not zoomed in/out)
-  : Next page (When the page has not zoomed in/out)

● Settings

Select "Settings" on the page.

- **Repeat mode:** Play mode.
Repeat once: All files are repeated once.
Repeat all: All files in the same folder play repeatedly.
- **Effect Duration:** PDF effect duration. 5s/10s/15s/20s

[iiSignage]

Set the Server/Account/PIN code/Version(Ver.2/Ver.3)*/Content(Internal storage/USB storage/SD card).

* When Ver.2, Server/Account/PIN code will turn to gray to indicate it is not available on this model.
When Ver.3, Server/Account/PIN code is available.

To be able to use the functionality , please download the iiSignage Software and User Manual from our Website <https://iiyama.com/iisignage>

iiSignage software is using the network Port: 9989 , future information are available in the iiSignage User Manual

[Chromium]

Connect the network, and browse the web.

[File Manager]

Browse the files stored in the internal storage, USB and SD card.

[Settings]

See page 35,36 for Settings.

[Custom]

Set up the application for Customer Source.

- NOTE**
- Only display user installed app.
 - Will not appear in the system pre-install app.

SCREEN ADJUSTMENTS

Adjust the image by following the procedure below to get the desired picture when selecting Analog input.

- The screen adjustments described in this manual are designed to set image position and minimize flicker or blur for the particular computer in use.
- The monitor is designed to provide the best performance at resolution of 3840 × 2160, but can not provide the best at resolutions of less than 3840 × 2160 because the picture is automatically stretched to fit the full screen. It is recommended to operate at resolution of 3840 × 2160 in normal use.
- Displayed text or lines will be blurred or irregular in thickness when the picture is stretched due to the screen enlargement process.
- It is preferable to adjust the image position and frequency with the monitor controls, rather than the computer software or utilities.
- Perform adjustments after a warm-up period of at least thirty minutes.
- Additional adjustments may be required after the Auto Adjust depending on the resolution or signal timing.
- The Auto Adjust may not work correctly when displaying the picture other than the screen adjustment pattern. In this case, manual adjustments are required.

There are two ways to adjust the screen. One way is automatic adjustment for Position, Clock and Phase. The other way is performing each adjustment manually.

Perform the Auto Adjust first when the monitor is connected to a new computer, or resolution is changed. If the screen has a flicker or blur, or the picture does not fit in the display area after performing the Auto Adjust, manual adjustments are required. Both adjustments should be made by using the screen adjustment pattern (Test.bmp) obtained via the Iiyama web site (<http://www.iiyama.com>).

Adjust the image by following the procedure below to get the desired picture.

This manual explains adjustment under Windows® OS.

- ① **Display the picture at the optimum resolution.**
- ② **Enter the Test.bmp (screen adjustment pattern) to wallpaper.**

NOTE

- Consult the appropriate documentation for doing this.
- Set the display position to center in the wallpaper setting dialogue box.

[Adjustment pattern]

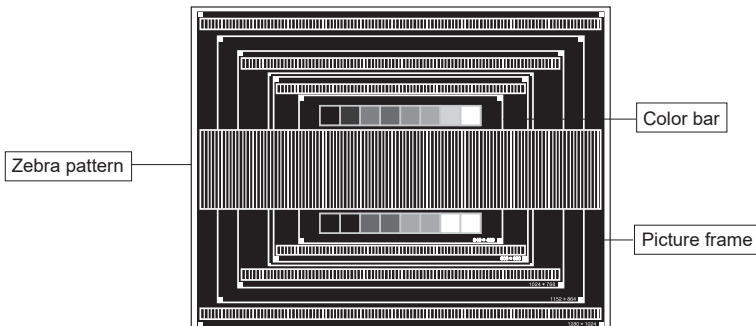

- ③ Adjust the Auto Adjustment. (Auto Adjust)
- ④ Adjust the image manually by following procedure below when the screen has a flicker or blur, or the picture does not fit in the display area after performing the Auto Adjust.
- ⑤ Adjust the V.Position so that the top and bottom of the picture frame will fit to the display area.

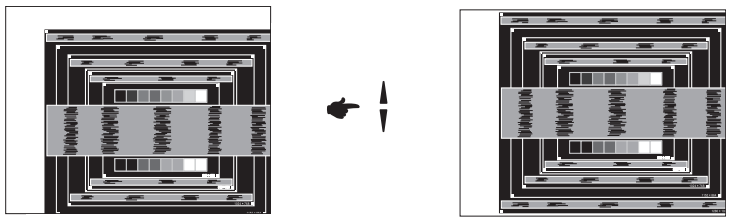

- ⑥ 1) Adjust the H.Position so that the left side of the picture frame will move to the left edge of the display area.

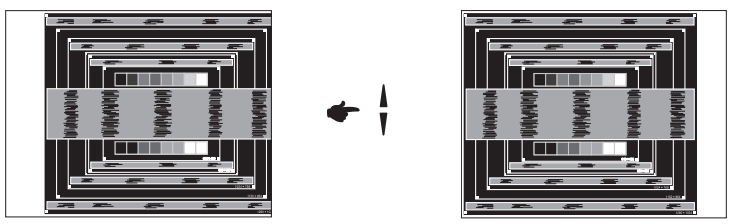

- 2) Stretch the right side of the picture frame to the right edge of the display area by adjusting the Clock.

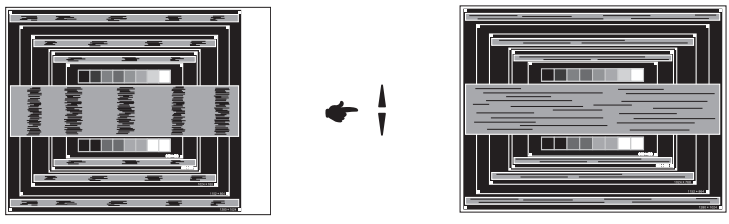

- NOTE**
- When the left side of the picture frame moves apart from the left edge of the display area during the Clock adjustment, adjust steps 1) and 2).
 - Another way to make the Clock adjustment is to correct the vertical wavy lines in the zebra pattern.
 - The picture may flicker during the Clock, H.Position and V.Position adjustment.
 - In case the picture frame is bigger or smaller than the data display area after the Pixel Clock adjustment, repeat steps from ③.

- ⑦ **Adjust the Phase to correct horizontal wavy noise, flicker or blur in the zebra pattern.**

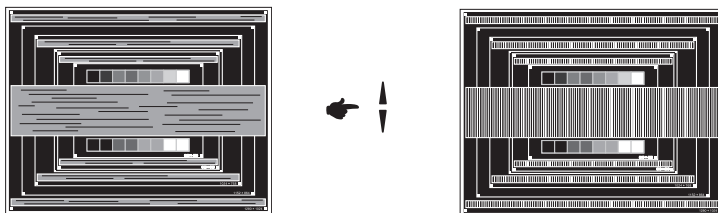

NOTE

- In case the strong flicker or blurs remain on a part of the screen, repeat steps ⑥ and ⑦ because the Clock may not be adjusted correctly.
- Adjust the H.Position after the Phase adjustment if the horizontal position moves during the adjustment.

- ⑧ **Adjust the Brightness and Color to get the desired picture after you complete the Clock and Phase adjustments.**

Put back your favorite wallpaper.

STANDBY FEATURE

The standby feature of this product complies with power saving requirement of VESA DPMS. When activated, it automatically reduces unnecessary power consumption of the monitor when your computer is not in use.

To use the feature, the monitor needs to be connected to a VESA DPMS compliant computer. There is a standby step the monitor takes as described below. The standby function, including any timer settings is configured by the operating system. Check your operating system manual for information on how this can be configured.

■ Standby Mode

When the video signal from the computer is off, the monitor enters into Standby Mode which reduces the power consumption to less than 0.5W*. The screen becomes dark, and the power indicator turns to red. From Standby Mode, the image reappears in several seconds when either the keyboard or the mouse are touched again.

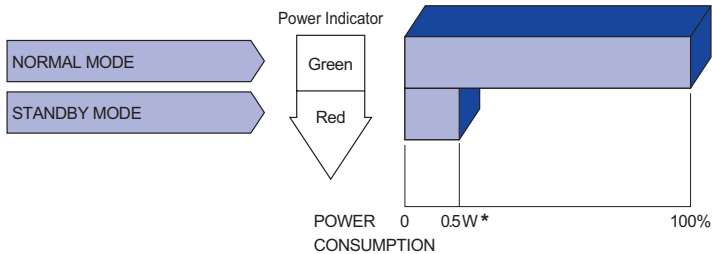

* USB peripherals and audio equipment are not connected.

NOTE

Even when using the standby mode, the monitor consumes electricity. Turn off the Power Switch whenever the monitor is not in use, during the night and weekends, to avoid unnecessary power consumption.

TROUBLE SHOOTING

If the monitor fails to operate correctly, please follow the steps below for a possible solution.

1. Perform the adjustments described in OPERATING THE MONITOR, depending on the problem you have. If the monitor does not get a picture, skip to 2.
2. Consult the following items if you cannot find an appropriate adjustment item in OPERATING THE MONITOR or if the problem persists.
3. If you are experiencing a problem which is not described below or you cannot correct the problem, discontinue using the monitor and contact your dealer or iiyama service center for further assistance.

Problem

Check

- | | |
|--|--|
| <p>① The picture does not appear.
(Power indicator does not light up.)</p> <p>(Power indicator is green.)</p> <p>(Power indicator is red.)</p> | <p><input type="checkbox"/> The Power Cable is firmly seated in the socket.</p> <p><input type="checkbox"/> The Power Switch is turned ON.</p> <p><input type="checkbox"/> The AC socket is live. Please check with another piece of equipment.</p> <p><input type="checkbox"/> If the blank screen saver is in active mode, touch the keyboard or the mouse.</p> <p><input type="checkbox"/> Increase the Contrast and/or Brightness.</p> <p><input type="checkbox"/> The computer is ON.</p> <p><input type="checkbox"/> The Signal Cable is properly connected.</p> <p><input type="checkbox"/> The signal timing of the computer is within the specification of the monitor.</p> <p><input type="checkbox"/> If the monitor is in standby mode, touch the keyboard or the mouse.</p> <p><input type="checkbox"/> The computer is ON.</p> <p><input type="checkbox"/> The Signal Cable is properly connected.</p> <p><input type="checkbox"/> The signal timing of the computer is within the specification of the monitor.</p> |
| <p>② The screen is not synchronized.</p> | <p><input type="checkbox"/> The Signal Cable is properly connected.</p> <p><input type="checkbox"/> The signal timing of the computer is within the specification of the monitor.</p> |
| <p>③ The screen position is not in the center.</p> | <p><input type="checkbox"/> The signal timing of the computer is within the specification of the monitor.</p> |
| <p>④ The screen is too bright or too dark.</p> | <p><input type="checkbox"/> The video output level of the computer is within the specification of the monitor.</p> |
| <p>⑤ The screen is shaking.</p> | <p><input type="checkbox"/> The power voltage is within the specification of the monitor.</p> <p><input type="checkbox"/> The signal timing of the computer is within the specification of the monitor.</p> |
| <p>⑥ No sound.</p> | <p><input type="checkbox"/> The audio equipment (computer etc.) is ON.</p> <p><input type="checkbox"/> The Audio Cable is properly connected.</p> <p><input type="checkbox"/> The Volume is turned up.</p> <p><input type="checkbox"/> The Mute is OFF.</p> <p><input type="checkbox"/> The audio output level of the audio equipment is within the specification of the monitor.</p> |
| <p>⑦ The sound is too loud or too quiet.</p> | <p><input type="checkbox"/> The audio output level of the audio equipment is within the specification of the monitor.</p> |
| <p>⑧ A strange noise is heard.</p> | <p><input type="checkbox"/> The Audio Cable is properly connected.</p> |

RECYCLING INFORMATION

For better environment protection please don't dispose your monitor.
Please visit our web site: www.iiyama.com for monitor recycling.

APPENDIX

Design and specifications are subject to change without prior notice.

SPECIFICATIONS : ProLite LH4342UHS-B3

ENGLISH

Size Category	43"	
LCD Panel	Panel technology	IPS
	Size	Diagonal: 42.5" (108cm)
	Pixel pitch	0.245mm H × 0.245mm V
	Brightness	500cd/m ² (Typical)
	Contrast ratio	1300 : 1 (Typical)
	Viewable angle	Horizontal : 178 degrees, Vertical: 178 degrees (Typical)
Response time	9ms (Typical, Gray to Gray)	
Display Colors	Approx. 1.07 Billion	
Sync Frequency	DVI: Horizontal: 30.0-80.0kHz, Vertical: 50-75Hz HDMI/DisplayPort: Horizontal: 30.0-135.0kHz, Vertical: 50-75Hz	
Native Resolution	3840 × 2160, 8.3 MegaPixels	
Support Max. Resolution	DVI: 1920 × 1080 60Hz HDMI/DisplayPort: 3840 × 2160 60Hz	
Input Connector	DVI-I, HDMI × 3, DisplayPort	
Input Audio Connector	ø 3.5mm mini jack (Stereo)	
LAN	RJ45	
Serial Port	RS-232C In/Out ø 2.5mm sub-mini jack	
Plug & Play	VESA DDC2B™	
Input Video Signal	Digital: DVI (Digital Visual Interface Standard Rev.1.0) compliance Digital: HDMI, DisplayPort	
Input Audio Signal	0.5Vrms maximum	
IR Extender Connector	IR In/Out	
USB Connector	USB2.0(DC5V, 500mA) (USB Media Player) × 2	
Micro SD card slot	Micro SD	
Output Connector	DisplayPort	
Speakers	Internal: 10W×2 (Stereo speakers)	
Maximum Screen Size	941.18mm W × 529.42mm H / 37.1" W × 20.8" H	
Power Source	100-240VAC, 50/60Hz, 2.4A	
Power Consumption*	116W typical, Standby mode: 0.5W maximum	
Dimensions / Net Weight	973.0 × 561.0 × 63.5mm / 38.3 × 22.1 × 2.5" (W×H×D) 10.7kg / 23.6lbs	
Environmental Considerations	Operating:	Temperature 0 to 40°C / 32 to 104°F Humidity 20 to 80% (No condensation)
	Storage:	Temperature -20 to 60°C / 4 to 140°F Humidity 5 to 95% (No condensation)
Approvals	CE, UKCA, EAC, TÜV-Bauart	

NOTE * USB peripherals and audio equipment are not connected.

SPECIFICATIONS : ProLite LH5042UHS-B3

Size Category	50"	
LCD Panel	Panel technology	VA
	Size	Diagonal: 49.5" (125.7cm)
	Pixel pitch	0.2854mm H × 0.2854mm V
	Brightness	500cd/m ² (Typical)
	Contrast ratio	4000 : 1 (Typical)
	Viewable angle	Horizontal : 178 degrees, Vertical: 178 degrees (Typical)
	Response time	8ms (Typical, Gray to Gray)
Display Colors	Approx.1.07 Billion	
Sync Frequency	DVI: Horizontal: 30.0-80.0kHz, Vertical: 50-75Hz HDMI/DisplayPort: Horizontal: 30.0-135.0kHz, Vertical: 50-75Hz	
Native Resolution	3840 × 2160, 8.3 MegaPixels	
Support Max. Resolution	DVI: 1920 × 1080 60Hz HDMI/DisplayPort: 3840 × 2160 60Hz	
Input Connector	DVI-I, HDMI × 3, DisplayPort	
Input Audio Connector	ø 3.5mm mini jack (Stereo)	
LAN	RJ45	
Serial Port	RS-232C In/Out ø 2.5mm sub-mini jack	
Plug & Play	VESA DDC2B™	
Input Video Signal	Digital: DVI (Digital Visual Interface Standard Rev.1.0) compliance Digital: HDMI, DisplayPort	
Input Audio Signal	0.5Vrms maximum	
IR Extender Connector	IR In/Out	
USB Connector	USB2.0(DC5V, 500mA) (USB Media Player) × 2	
Micro SD card slot	Micro SD	
Output Connector	DisplayPort	
Speakers	Internal: 10W×2 (Stereo speakers)	
Maximum Screen Size	1095.84mm W × 616.41mm H / 43.1" W × 24.3" H	
Power Source	100-240VAC, 50/60Hz, 2.8A	
Power Consumption*	147W typical, Standby mode: 0.5W maximum	
Dimensions / Net Weight	1128.5 × 649.0 × 63.5mm / 44.4 × 25.6 × 2.5" (W×H×D) 14.7kg / 32.4lbs	
Environmental Considerations	Operating: Temperature 0 to 40°C / 32 to 104°F Humidity 20 to 80% (No condensation) Storage: Temperature -20 to 60°C / 4 to 140°F Humidity 5 to 95% (No condensation)	
Approvals	CE, UKCA, EAC, TÜV-Bauart	

NOTE * USB peripherals and audio equipment are not connected.

SPECIFICATIONS : ProLite LH5542UHS-B3

ENGLISH

Size Category	55"		
LCD Panel	Panel technology	IPS	
	Size	Diagonal: 54.6" (138.8cm)	
	Pixel pitch	0.315mm H × 0.315mm V	
	Brightness	500cd/m ² (Typical)	
	Contrast ratio	1300 : 1 (Typical)	
	Viewable angle	Horizontal : 178 degrees, Vertical: 178 degrees (Typical)	
	Response time	9ms (Typical, Gray to Gray)	
Display Colors	Approx. 1.07 Billion		
Sync Frequency	DVI: Horizontal: 30.0-80.0kHz, Vertical: 50-75Hz HDMI/DisplayPort: Horizontal: 30.0-135.0kHz, Vertical: 50-75Hz		
Native Resolution	3840 × 2160, 8.3 MegaPixels		
Support Max. Resolution	DVI: 1920 × 1080 60Hz HDMI/DisplayPort: 3840 × 2160 60Hz		
Input Connector	DVI-I, HDMI × 3, DisplayPort		
Input Audio Connector	ø 3.5mm mini jack (Stereo)		
LAN	RJ45		
Serial Port	RS-232C In/Out ø 2.5mm sub-mini jack		
Plug & Play	VESA DDC2B™		
Input Video Signal	Digital: DVI (Digital Visual Interface Standard Rev.1.0) compliance Digital: HDMI, DisplayPort		
Input Audio Signal	0.5Vrms maximum		
IR Extender Connector	IR In/Out		
USB Connector	USB2.0(DC5V, 500mA) (USB Media Player) × 2		
Micro SD card slot	Micro SD		
Output Connector	DisplayPort		
Speakers	Internal: 10W×2 (Stereo speakers)		
Maximum Screen Size	1209.6mm W × 680.4mm H / 47.6" W × 26.8" H		
Power Source	100-240VAC, 50/60Hz, 3.0A		
Power Consumption*	133W typical, Standby mode: 0.5W maximum		
Dimensions / Net Weight	1242.0 × 712.5 × 63.5mm / 48.9 × 28.1 × 2.5" (W×H×D) 16.7kg / 36.8lbs		
Environmental Considerations	Operating:	Temperature	0 to 40°C / 32 to 104°F
		Humidity	20 to 80% (No condensation)
	Storage:	Temperature	-20 to 60°C / 4 to 140°F
		Humidity	5 to 95% (No condensation)
Approvals	CE, UKCA, EAC, TÜV-Bauart		

NOTE * USB peripherals and audio equipment are not connected.

DIMENSIONS : ProLite LH4342UHS

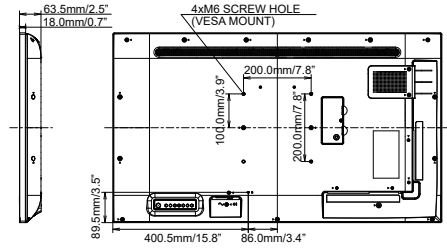
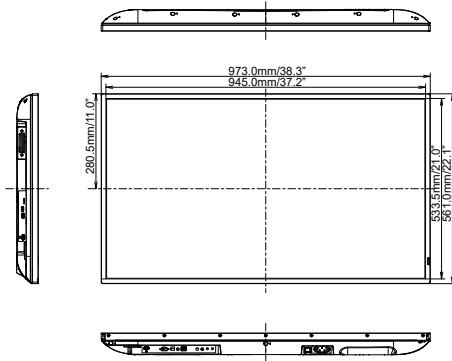

DIMENSIONS : ProLite LH5042UHS

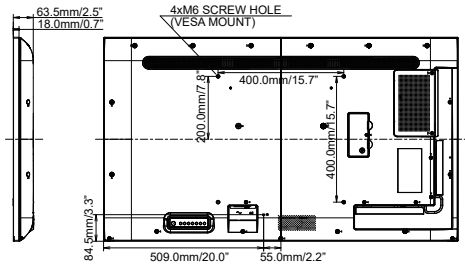
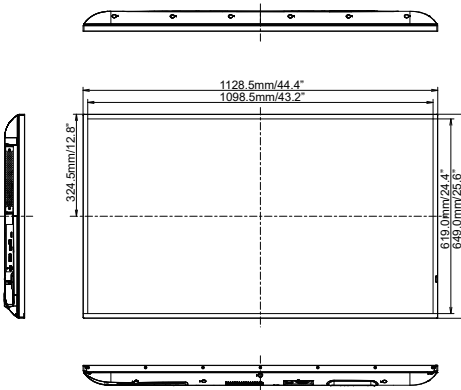

DIMENSIONS : ProLite LH5542UHS

ENGLISH

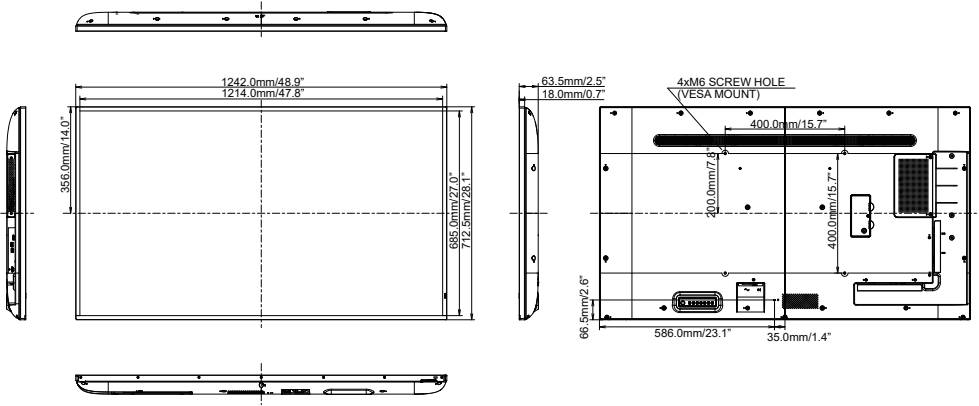

COMPLIANT TIMING

Timing		fH(kHz)	fV(Hz)	Dot clock (MHz)	VGA(via DVI)	DVI	HDMI1	HDMI2	HDMI3	DisplayPort
VESA	VGA 640x480	31.5	60.0	25.175	○	○	○	○	○	○
	SVGA 800x600	37.9	60.0	40.000	○	○	○	○	○	○
	XGA 1024x768	48.4	60.0	65.000	○	○	○	○	○	○
	WXGA 1280x768	47.8	60.0	79.500	○	○	○	○	○	○
	QVGA 1280x960	60.0	60.0	108.000	○	○	○	○	○	○
	SXGA 1280x1024	64.0	60.0	108.000	○	○	○	○	○	○
	HD FWXGA 1366x768	47.7	60.0	85.500	○	○	○	○	○	○
	CVT 1400x900	55.9	60.0	106.500	○	○	○	○	○	○
	WSXGA 1680x1050	65.3	60.0	146.250	○	○	○	○	○	○
FHD 1920x1080		67.5	60.0	148.500	○	○	○	○	○	○
	4K 3840x2160	67.5	30.0	297.000						
		135.0	60.0	594.000						
IBM	720x400	31.5	70.0	28.320	○	○	○	○	○	○
SD	NTSC-M	15.7	60.0	13.500						
	NTSC-J	15.7	60.0	13.500						
	PAL-BDGI	15.7	60.0	13.500						
	480i	60Hz	15.7	60.0	13.500					
	576i	50Hz	15.6	50.0	13.500					
	480p	60Hz	31.5	60.0	27.000					
576p	50Hz	31.3	50.0	27.000						
HD	720p	50Hz	37.5	50.0	74.250					
		60Hz	45.0	60.0	74.250					
	1080i	50Hz	28.1	50.0	74.250					
		60Hz	33.8	60.0	74.250					
	1080p	50Hz	56.3	50.0	148.500					
		60Hz	67.5	60.0	148.500					

* ○ means supported the timing.