

Elevador de pared sujetado al suelo para pantallas (táctiles) de gran formato 65" hasta 86"

Gracias a sus columnas dobles, este mejorado elevador asegura estabilidad y robustez adicionales para trabajar con pantallas táctiles 65" de hasta 86", 120 kg. La pantalla se puede ajustar fácilmente en altura con el control remoto y el ajuste eléctrico de altura es muy silencioso. En la parte posterior hay espacio reservado para colocar una mini PC o un cliente ligero.

01 ESPECIFICACIÓN TÉCNICA

Tipo	Elevador para el montaje vertical
Número de pantallas	1
Tamaño de pantalla	65" - 86"
Ajuste de altura	870mm, 936 - 1806mm
Peso máximo	120kg / monitor
VESA maximum	800 x 600mm

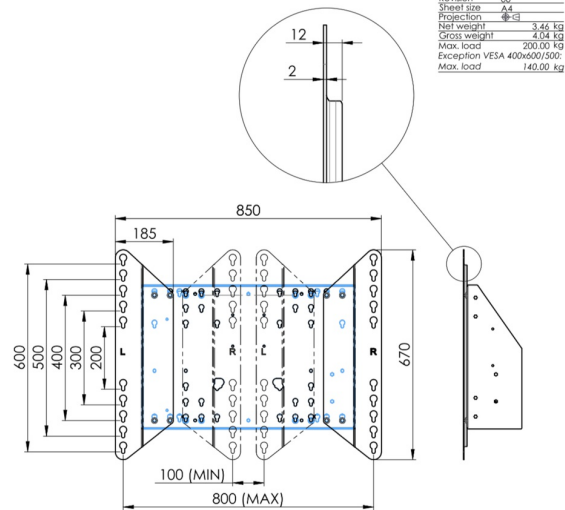
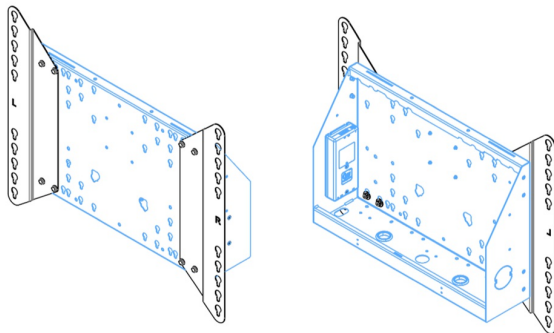
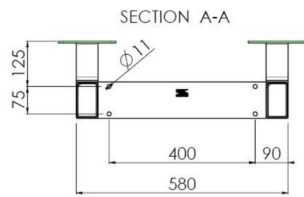
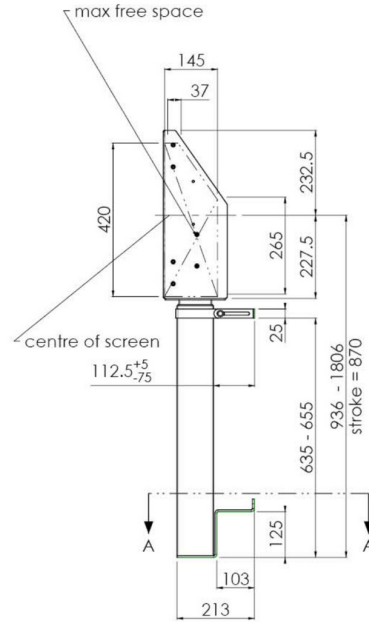
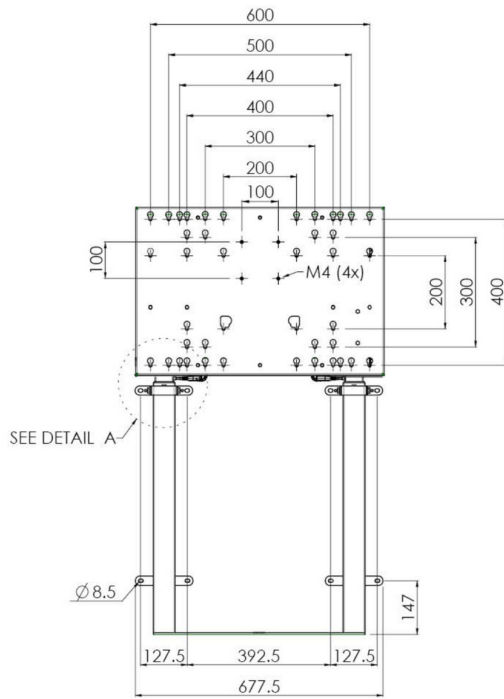
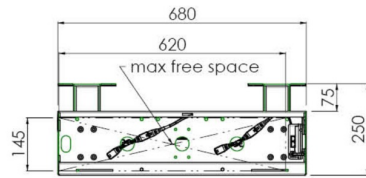

Dimensions	mm (inch)
Revision	00
Sheet size	A4
Projection	1st
Net weight	3.46 kg
Gross weight	4.34 kg
Max. load	200.00 kg
Exception VESA	400x500/500
Max. load	140.00 kg

02 DIMENSIONES / PESO

Peso (sin caja)

36kg

Código EAN

4948570032617

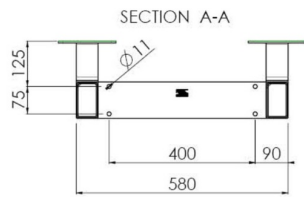
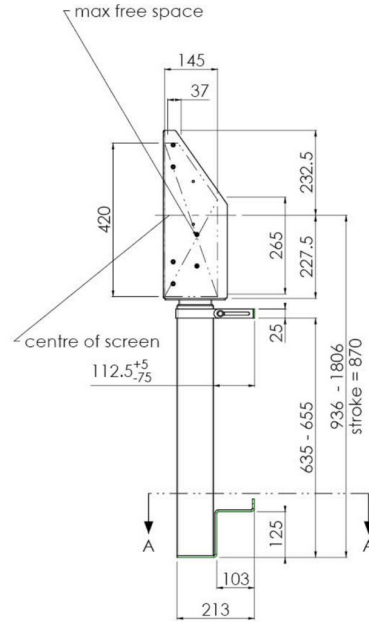
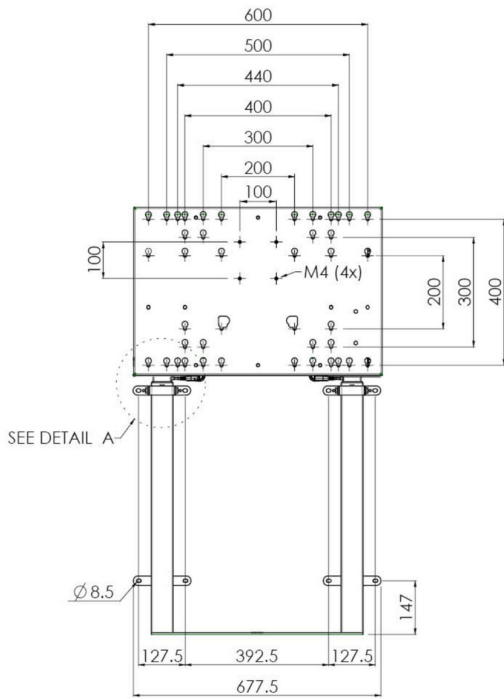
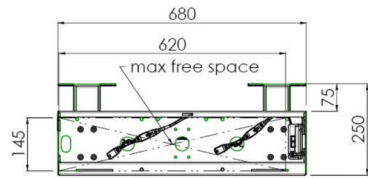

Dimensions	mm (inch)
Revision	00
Sheet size	A4
Projection	1E-3
Net weight	3.46 kg
Gross weight	4.34 kg
Max. load	200.00 kg
Exception VESA	400x600/500
Max. load	140.00 kg

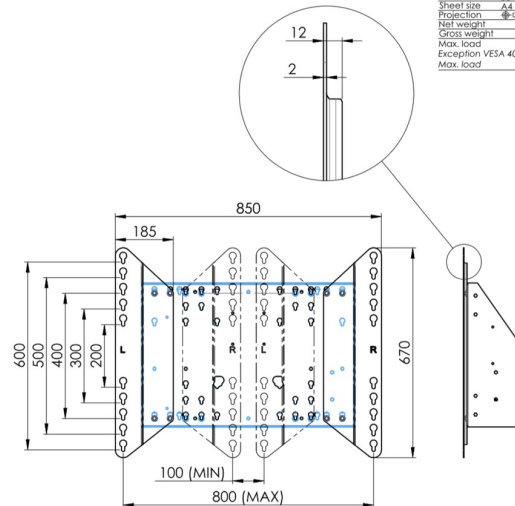
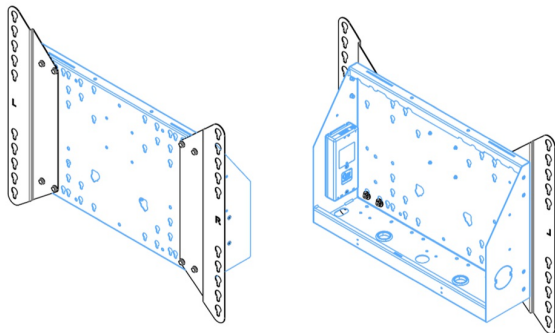

All trademarks and registered trademarks acknowledged. E & O E. Specification subject to change without notice. All LCD's comply with ISO-9241-307:2008 in connection with pixel defects.